

# MEITRACK MD811H MDVR User Guide



## Change History

File Name	MEITRACK MD811H MDVR User Guide		
Project	MD811H	Creation Date	2019-11-25 2022-04-28
Subproject	User Guide	Total Pages	52
Version	V2.0	Confidential	External Documentation

## Contents



1 Copyright and Disclaimer.....	5 -
2 Product Introduction .....	5 -
2.1 Product Overview .....	5 -
2.2 Product Functions.....	5 -
2.2.1 DVR Functions.....	5 -
2.2.2 Position Tracking.....	5 -
2.2.3 Alerts.....	6 -
2.2.4 Other Functions .....	6 -
2.2.5 Function Accessories .....	6 -
2.3 Product Specifications .....	6 -
2.4 Main Device and Accessories.....	8 -
2.5 About the MDVR.....	10 -
2.5.1 Appearance.....	10 -
2.5.2 Interface Definition .....	10 -
2.5.3 LED indicator .....	11 -
2.5.4 I/O Port .....	12 -
3 How it Works .....	14 -
3.1 Working Diagram .....	14 -
3.2 Dual System Mode.....	14 -
3.3 Dual System Mode.....	15 -
3.4 Working Mode.....	16 -
3.5 Peripheral Wiring Diagram.....	17 -
4 Fast Installing and Using the MDVR.....	18 -
4.1 Installing the MDVR .....	18 -
4.2 Configuring the MDVR by Using Meitrack Manager .....	22 -
4.3 Logging In to the Platform .....	24 -
5 Configuring the MDVR by Using the LAN Web Page.....	32 -
6 MS03 Web Platform .....	33 -
6.1 Real-time Monitoring .....	34 -
6.2 Video Playback.....	35 -
6.3 Two-Way Calling .....	37 -
7 MS03 App .....	39 -
7.1 Logging In to the App.....	39 -
7.2 Checking MDVR Online Status .....	39 -
7.3 Video Surveillance .....	40 -
8 Playing MDVR Videos by Using MT Player Software.....	42 -
8.1 Installing MT Player .....	42 -
8.2 MT Player Functions .....	43 -
8.2.1 Querying GPS Positioning Data .....	43 -
8.2.2 Playing Videos.....	44 -
9 FAQs.....	47 -
9.1 MDVR Abnormal.....	47 -
9.2 Data Usage Consumption .....	47 -

---

9.3 Power Consumption .....	- 49 -
9.4 Video Storage .....	- 49 -
9.5 Camera Installation.....	- 50 -

# 1 Copyright and Disclaimer

Copyright © 2022 MEITRACK. All rights reserved.

 ,  and  are trademarks that belong to Meitrack Group and its subsidiary.

The user manual may be changed without notice.

Without prior written consent of Meitrack Group, this user manual, or any part thereof, may not be reproduced for any purpose whatsoever, or transmitted in any form, either electronically or mechanically, including photocopying and recording.

Meitrack Group shall not be liable for direct, indirect, special, incidental, or consequential damages (including but not limited to economic losses, personal injuries, and loss of assets and property) caused by the use, inability, or illegality to use the product or documentation.

## 2 Product Introduction

### 2.1 Product Overview

The MD811H is an 8-channel HD mobile digital video recorder (MDVR) featuring double systems (double communication channels) and high stability. Adopting the high-performance processor and Linux operating system, it is a core product of new-generation wireless vehicle video surveillance solutions that uses H.264 video compression/decompression, GPS positioning and wireless data transmission technologies. The device is specially designed for mobile video surveillance for different types of vehicles, such as buses, long-distance coaches, taxis, logistics vehicles, armored cars, private cars, etc.

### 2.2 Product Functions

#### 2.2.1 DVR Functions

- 8-channel 1080P live video recording
- Automatic video overlaying
- Video search and playback via the platform or software
- Video downloading via the platform
- OSD overlay for video recording
- SOS alert recording
- Alert photo capturing
- Image quality settings

#### 2.2.2 Position Tracking

- GPS + LBS positioning
- Real-time location query
- Tracking by time interval
- Tracking by distance
- Tracking by mobile phone
- Speeding alert
- Cornering report
- Braking alert and turning left/right alert

### 2.2.3 Alerts

- SOS alert
- GPS antenna cut-off alert
- External power supply cut-off alert
- GPS blind spot alert
- Engine or vehicle door status alert
- Geo-fence
- Video signal lost alert

### 2.2.4 Other Functions

- Support a CAN bus interface
- Support the speedometer RPM
- Support a RFID reader
- Support multiple types of fuel level sensors
- Support a LED display
- Support two-way calling
- Upload data via 4G, WiFi, or Ethernet
- Configure the MDVR by using the local area network (LAN) web page
- Play videos by using MT Player software
- Support the 2.4 GHz WiFi hotspot function
- Double System Working in parallel

### 2.2.5 Function Accessories

Accessory	Function
8 cameras	Audio and video sensing equipment
4 video splitters (1 to 2)	An 8-channel video aviation connector can be expanded from a 4-channel video aviation connector.
Hard disk & SD card	Store audio and video data.
Display	Play audio and video files in real time through a single channel or all channels.
Handset	Communicate with the monitoring platform in real time.
Speaker and microphone	Used for two-way calling and remote listen-in.
Hard disk lock key	Open or close the hard disk lock.
USB cable	Configure parameters.

## 2.3 Product Specifications

Item	Parameter	Specifications
System Struction	System Operation	Double Systems Working in parallel, double communication channels(in case of data loss)
Audio and video	Video input	8-channel 1080P@25FPS live video recording
	Video output	1-channel CVBS + 1-channel VGA
	Compression	H.264

	standard	
	Image display	Support one-image and nine-image display
	Audio compression	G.726
	Audio input	9-channel audio input; 8-channel AV-IN interface; 1-channel voice intercom interface
	Audio output	1-channel independent audio DC blocking output (connected to the AV-OUT interface, VGA aviation connector, or handset interface)
	Video search and playback	Search and play back videos based on the channel, recording type, or time.
	Recording method	Simultaneously record the ACC, alert, sound, and video.
	Storage medium	1 SD card and 1 SATA hard drive/SSD hard drive
2G/3G/4G	MD811H-E	GSM: B3/B8 WCDMA: B1/B8 LTE FDD: B1/B3/B7/B8/B20/B28A
	MD811H-A	WCDMA: B2/B4/B5 LTE FDD: B2B4/B12
	MD811H-AU	GSM: B2/B3/B5/B8 WCDMA: B1/B2/B5/B8 LTE FDD: B1/B2/B3/B4/B5/B7/B8/B28 LTE TDD: B40
	MD811H -J	WCDMA: B1/B6/B8/B19 LTE FDD: B1/B3/B8/B18/B19/B26 LTE TDD: B41
	MD811H -G	GSM: B2/B3/B5/B8 WCDMA: B1/B2/B4/B5/B6/B8/B19 LTE FDD: B1/B2/B3/B4/B5/B7/B8/B12/B13/B25/B26/B18/B19/B20/B28 LTE TDD: B38/B39/B40/B41
WiFi	802.11 b/g/n; frequency: 2.4 GHz	
GPS/GLONASS	Detect the insertion, pull-out, and short circuit of the antenna.	
Interface	AV input	8-channel aviation connector
	AV output	AV-OUT 1 of 1-channel aviation connector + VGA of 1-channel aviation connector
	Platform voice intercom	1-channel aviation connector
	Voice calling	3.5 mm audio interface
	Sensor interface	1 sensor interface. Used to connect a fuel level sensor, a temperature sensor, or an A61 sensor box.
	Hard disk interface	1 SATA interface; up to 2 TB; support hard disk auto-heating.
	USB port	1 USB 2.0 port (support USB flash drive or mouse)
	Internet	RJ45; 10 MB / 100 MB adaptive network interface

	interface	
	Ignition input	1 ACC signal interface
	RS232	2 RS232 interfaces
	RS485	1 RS485 interface
	CAN	1 CAN bus interface
	Infrared interface	Reserved; 1 built-in infrared receiver
	LED indicator	8 LED indicators (SYS/GPS/3G&4G/VLOSS/HDD/SD/PWR/WIFI)
	Hard disk lock	1
	G-sensor	Start to Move / Stop Moving detection
	Alert input	8 digital inputs SOS, door side 1, door side 2, turning left, turning right, reversing, braking, and vehicle speed line
	Alert output	3 outputs
	AD	Reserved; 2 AD interfaces; detect 0–6.6 V inputs.
	Debug and upgrade interface	Debug the system and update the firmware through a serial port.
Protocol	Protocol supported	Meitrack protocol
Software upgrade	Upgrade mode	Manual upgrade
	Upgrade method	(1) Plug the USB flash drive with the firmware into the USB port to automatically upgrade the device (or connect the device to the computer through the debug interface and then start Meitrack Manager software to upgrade the device). (2) Use the LAN web page to upgrade the firmware (WiFi or Ethernet). (3) OTA update.
Others	Power input	DC: 8–36 V/A
	Power consumption	Start the host audio and video: about 8 W Connect 8 cameras: about 24 W in the daytime (connect a display: 29 W); about 32 W at night (connect a display: 37 W) Connect a single camera: 50–100 mA in the daytime; 200–250 mA at night
	Operating temperature	-20°C to 70°C
	Weight	2000g (excluding the hard disk)
	Dimension	177 mm x 162 mm x 63 mm

## 2.4 Main Device and Accessories



Standard Accessory	Quantity	Description
MD822S MDVR	1	
GPS antenna	1	Boost your device's GPS signal.
4G antenna	2	Boost your device's 4G signal. Main antenna and auxiliary antenna.
WiFi antenna	1	Boost your device's WiFi signal.
Power & ACC cable	1	3-pin cable. The cable is 20 cm in length.
I/O cable	1	20-pin cable. The cable is 20 cm in length.
Camera splitter	4	There is one 6-pin female aviation connector on one end of the cable and two 4-pin male aviation connectors on the other end. The cable is 20 cm in length.
USB cable	1	Connect to a PC to configure device parameters and upgrade software.
Lock key	2	Used to lock an SD card and SIM card (and power on or power off the device).
CD download card	1	

Optional Accessory	Description
AHD 1080P camera	
AHD 720P camera	
D1 camera	
Camera extension cable	Users can select a cable three meters or five meters in length by default. Other cables (0.5–20 meters) need to be customized.
SD card	An SD card with 32 GB, 64 GB, 128 GB, and 256 GB of memory is available.
VGA display	
CVBS display	
Handset	The handset cable is one meter in length.
A76 ultrasonic fuel level sensor	
A53 fuel level sensor	
A61 sensor box	
Temperature sensor	The sensor cable is five meters in length by default.
RFID reader	
RFID tag	RFID tags are provided based on users' needs.
iButton reader	
iButton key	iButton keys are provided based on users' needs.
Microphone and speaker	

## 2.5 About the MDVR

### 2.5.1 Appearance



Figure 2.5.1 Front panel

1. Screws for fastening the disk enclosure
2. Hard disk lock (To enable the recording function, ensure that the hard disk is locked after the disk enclosure is installed properly.)
3. USB port
4. Debug interface
5. LED indicator
6. Audio interface for the microphone and speaker



Figure 2.5.2 Rear panel

### 2.5.2 Interface Definition

Interface	Label	Description
Infrared interface	IR	Infrared receiver (reserved function)
USB port	USB	Standard USB port
3G/4G main antenna connector	3G/4G	SMA connector; 3G/4G main antenna

Interface	Label	Description
GPS antenna connector	GPS	GPS antenna connector
WiFi antenna connector	WiFi	WiFi antenna connector
Voice intercom I/O port	MIC&SPK	Connect the handset to communicate with the monitoring platform.
Audio	Audio	Connect the microphone and speaker to implement two-way calling and remote listen-in.
AV output	VGA/AV-OUT	Connect the display to play audio and video files.
AV input	CAM1–CAM8	AV input port, used to connect an 8-channel AHD 1080P camera.
Ethernet interface	ETH	10Mbps/100Mbps self-adaptive Ethernet interface
Main line interface	IO&AD&RS485&CAN	8 GPIO inputs, 3GPIO outputs, 1 RS485J interface, 1 AD interface, and 1 CAN bus interface
Sensor interface	SENSOR	Used to connect a fuel level sensor, temperature sensor, iButton reader or A61 sensor box.
RS232 interface	RS232 EXT	Used to connect a RFID reader.
Serial communication interface	RS232/RS485	RS232 interface by default, used to connect related devices.
Power & ACC interface	PWR	Input voltage: 11–36 V. The yellow cable is the ACC detection cable.

### 2.5.3 LED indicator

Label	LED Indicator	Status	Description
PWR	Power LED indicator	Steady on	The ACC is on and the device is locked.
		Steady off	The ACC is off and the device is unlocked.
WIFI	WiFi LED indicator	Blink suddenly (once every 5 seconds; indicator on: 100 ms)	There is a WiFi module, but no data is sent.
		Blink fast	WiFi data is sent and received normally.
		Steady off	There is no WiFi module.
HDD	Hard disk LED indicator	Blink fast (frequency for writing data)	A storage disk is detected, and audio and video data is written into the storage disk.
		Blink suddenly (once every 5 seconds; indicator on: 100 ms)	A storage disk is detected, but no data is written into the storage disk.
		Steady off	No storage disk is detected.
SD	SD card LED indicator	Blink fast (frequency for writing data)	An SD card is detected and there is written audio and video data in the SD card.
		Blink suddenly (once every 5 seconds; indicator on: 100 ms)	An SD card is detected and no data is written into the SD card.
		Steady off	No SD card is detected.
3G/4G	3G/4G LED indicator	Blink suddenly (once every 5 seconds; indicator on: 100 ms)	There is a 3G/4G module, but no data is sent.
		Blink fast	3G/4G data is sent and received normally.
		Steady off	There is no 3G/4G module.
SYS	Network status LED	Steady on	There is an incoming call, or the subscriber

	indicator		you dialed is busy now.
		Blink fast (once every 0.1 seconds)	The MDVR is being initialized.
		Blink fast (0.1 seconds on and 2.9 seconds off)	A signal is received from a base station (connected to a mobile network).
		Blink slowly (1 second on and 2 seconds off)	No signal is received from a base station (not connected to a mobile network).
GPS	GPS LED indicator	Steady on	A button or an input is triggered.
		Blink fast (once every 0.1 seconds)	The MDVR is being initialized, or the battery power is low.
		Blink fast (0.1 seconds on and 2.9 seconds off)	A GPS signal is received.
		Blink slowly (1 second on and 2 seconds off)	No GPS signal is received.
VLOSS	Video lost LED indicator	Steady on	All AV inputs are not connected to cameras.
		Blink suddenly (once every 5 seconds; indicator on: 100 ms)	One AV input is not connected to a camera.
		Blink suddenly (twice every 5 seconds; indicator on: 100 ms; interval: 300 ms)	Two AV inputs are not connected to cameras.
		Blink suddenly (3 times every 5 seconds; indicator on: 100 ms; interval: 300 ms)	Three AV inputs are not connected to cameras.
		Blink suddenly (4 times every 5 seconds; indicator on: 100 ms; interval: 300 ms)	Four AV inputs are not connected to cameras.
		Blink suddenly (5 times every 5 seconds; indicator on: 100 ms; interval: 300 ms)	Five AV inputs are not connected to cameras.
		Blink suddenly (6 times every 5 seconds; indicator on: 100 ms; interval: 300 ms)	Six AV inputs are not connected to cameras.
		Blink suddenly (7 times every 5 seconds; indicator on: 100 ms; interval: 300 ms)	Seven AV inputs are not connected to cameras.
		Steady off	All AV inputs are connected to cameras.

### 2.5.4 I/O Port



Pin Number	Label	Function Description
1	OUT3	Output 3; low level triggering by default (0 V); invalid: open collector Maximum voltage for output open collector (invalid): 40 V. Maximum current: 400 mA. Allow to set the high level triggering mode and PWM triggering mode. Connect an external relay to remotely cut off the vehicle fuel or engine power supply.
2	OUT2	Output 2; low level triggering by default (0 V); invalid: open collector Maximum voltage for output open collector (invalid): 40 V. Maximum current: 400 mA. Allow to set the high level triggering mode and PWM triggering mode. Connect an external relay to remotely cut off the vehicle fuel or engine power supply.
3	TLEFT_DET	Connect the turning left signal cable.
4	TRIGHT_DET	Connect the turning right signal cable.
5	BRAKING_DET	Connect the braking signal cable.
6	DOOR2_DET	Connect the vehicle door side signal cable.
7	TBACK_DET	Connect the reversing signal cable.
8	SPEED_IN	Connect the vehicle speed signal cable.
9	DOOR1_DET	Connect the vehicle door side signal cable.
10	AD1	Analog input 1 with 12-bit resolution; valid voltage: 0–30 V Connect an external sensor, such as the fuel level sensor.
11	None (reserved)	None (reserved)
12	None (reserved)	None (reserved)
13	OUT1	Output 1; low level triggering by default (0 V); invalid: open collector Maximum voltage for output open collector (invalid): 40 V. Maximum current: 400 mA. Allow to set the high level triggering mode and PWM triggering mode. Connect an external relay to remotely cut off the vehicle fuel or engine power supply.
14	None (reserved)	None (reserved)
15	RS485_B-	RS485 B- signal cable (RS485 interface) Connect the negative terminal of the camera cradle head.
16	RS485_A+	RS485 A+ signal cable (RS485 interface) Connect the positive terminal of the camera cradle head.
17	GND	Ground wire
18	CAN_L	Connect a CAN bus peripheral.
19	CAN_H	Connect a CAN bus peripheral.
20	GND	Ground wire
21	GND	Ground wire
22	GND	Ground wire
23	SOS	SOS alert input cable

24	None (reserved)	None (reserved)
----	-----------------	-----------------

### 3 How it Works

#### 3.1 Working Diagram

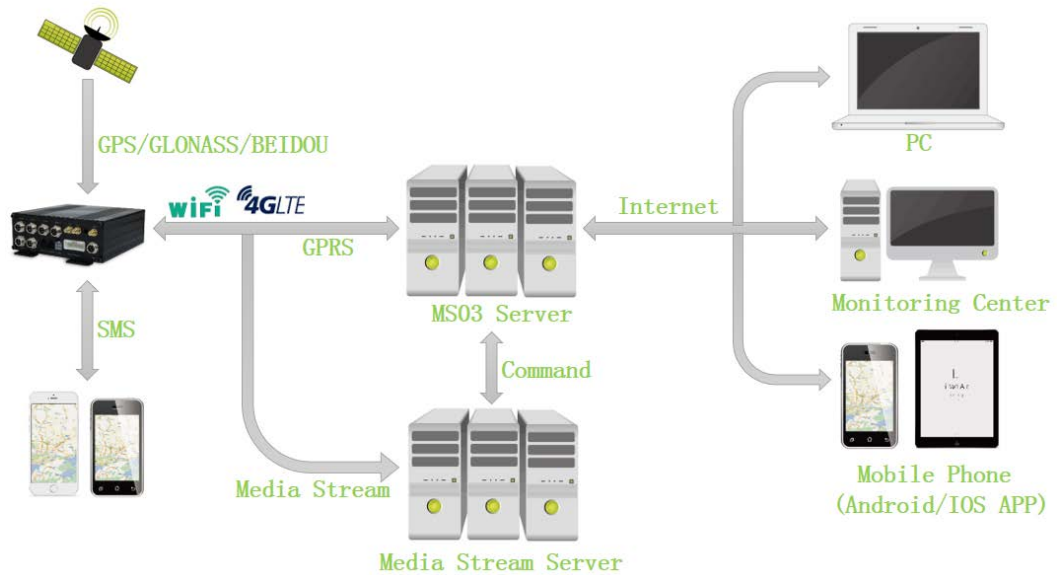

MD811H working diagram

#### 3.2 Dual System Mode

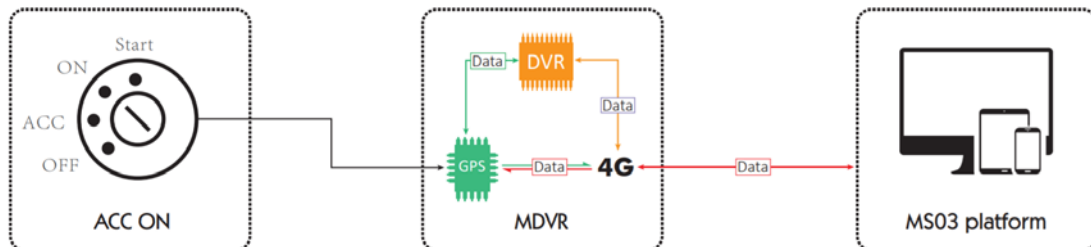

As shown in the preceding figure, the video system and vehicle tracking system operate simultaneously.

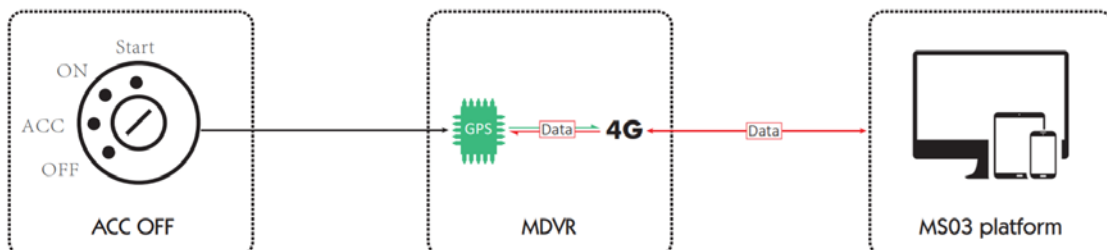

As shown in the preceding figure, the video system stops operating, while the vehicle tracking system is operating.

### 3.3 Dual System Mode

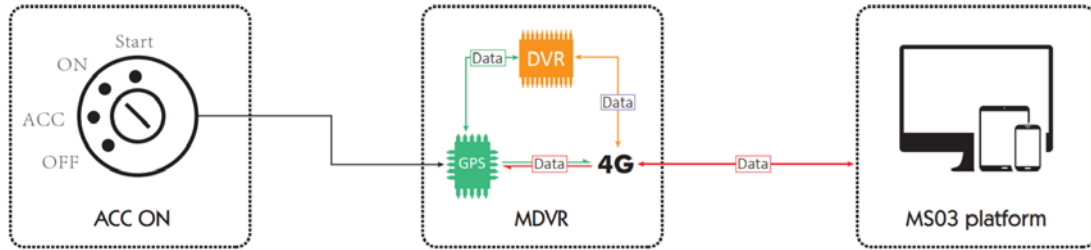

As shown in the preceding figure, the video system and vehicle tracking system operate simultaneously.

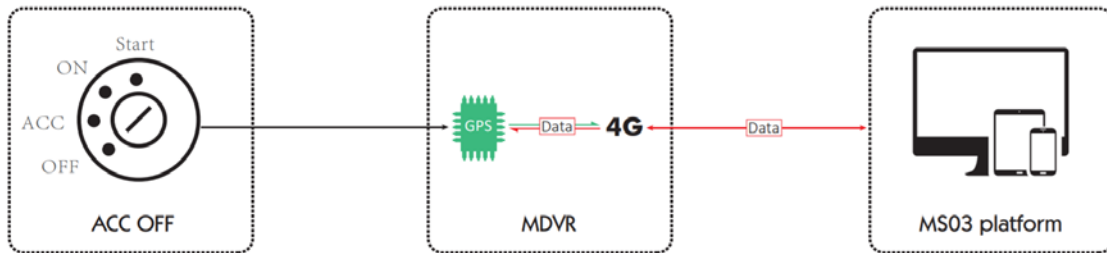

As shown in the preceding figure, the video system stops operating, while the vehicle tracking system is operating.

### 3.4 Working Mode

#### MDVR Working Mode

##### Working mode 1: Video recording (network disconnected)

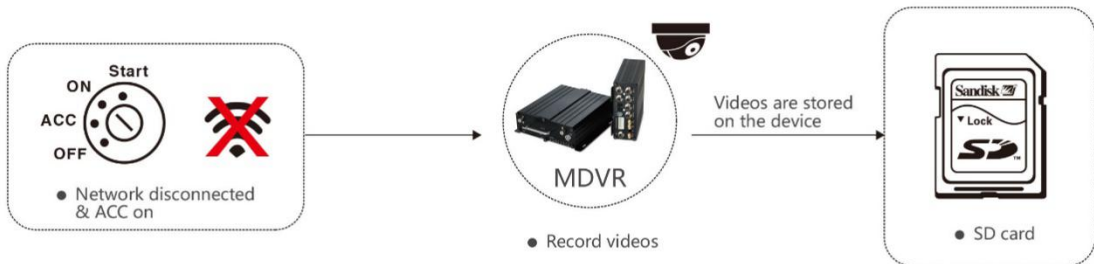

##### Working mode 2: Real-time video surveillance

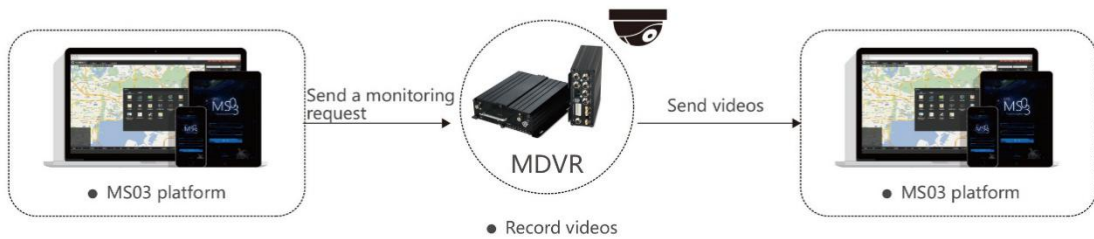

##### Working mode 3: Alert triggering and uploading

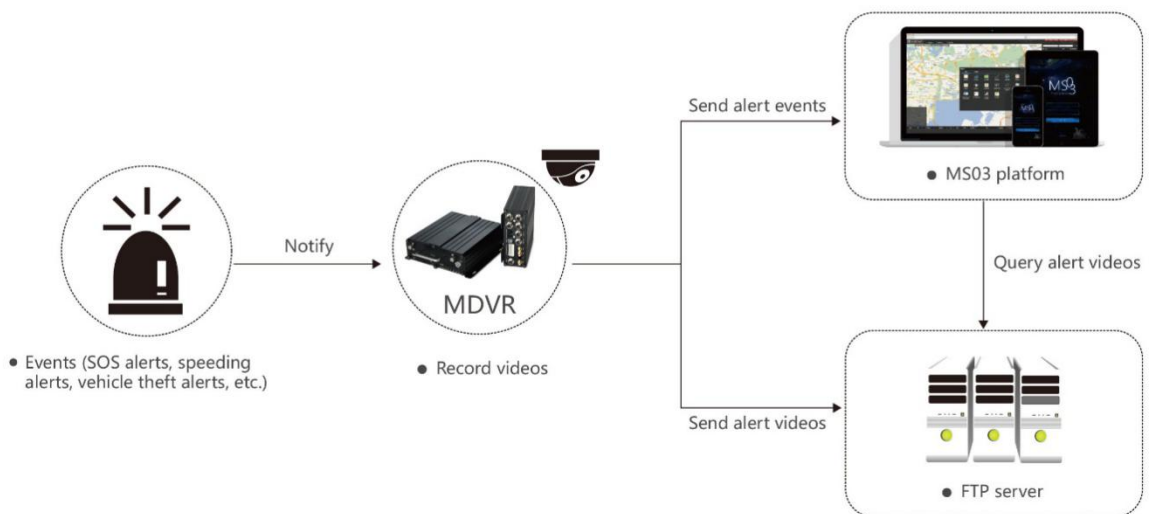



**Working mode 4: Alert video search and uploading**

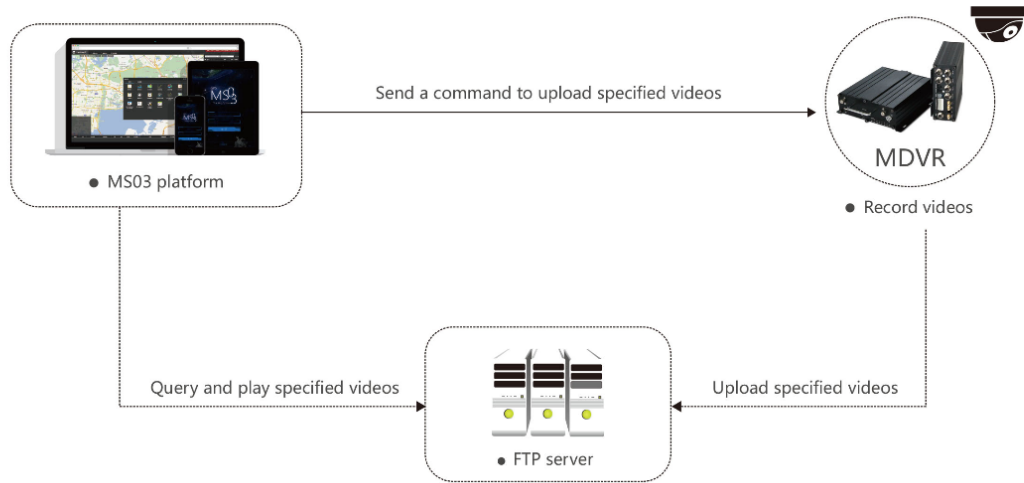

**3.5 Peripheral Wiring Diagram**

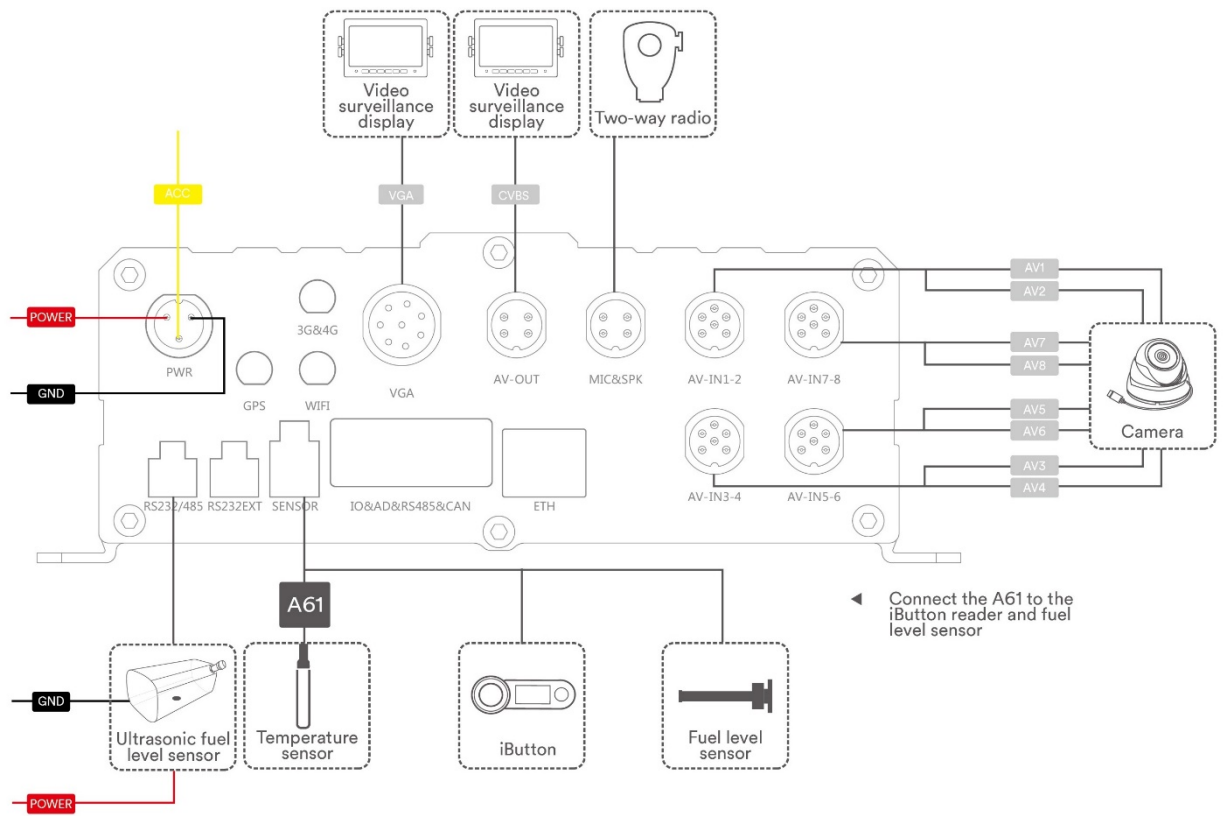

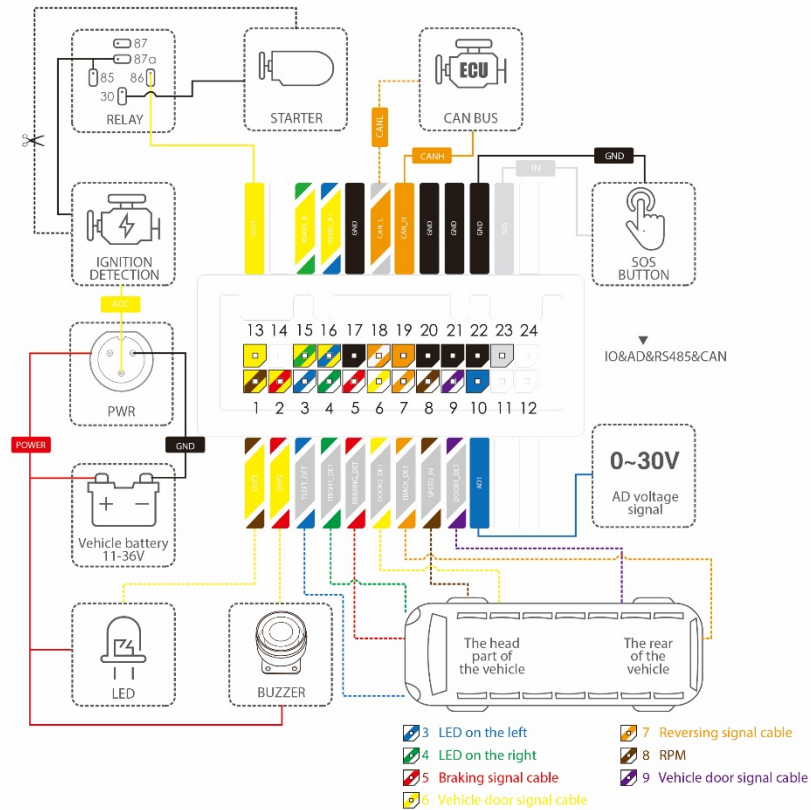

## 4 Fast Installing and Using the MDVR

Perform the following nine steps to fast install and use the MDVR:

- 1) Loosen the screws, insert the key to open the hard disk lock, pull out the disk enclosure, and install a hard disk.
- 2) Insert the SIM card into the SIM card slot. (You will see the card slot after pulling out the hard disk.)
- 3) Install an SD card as required.
- 4) Connect four cameras, the display, handset, GSM antenna, WiFi antenna and GPS antenna.
- 5) Connect the power cable (including the VCC, GND and ACC cables) to the external power supply. (The ACC cable must be connected to the positive terminal of the external power supply. Otherwise, the MDVR cannot be started.)
- 6) Set the IP address and port of the platform.
- 7) Set the data transmission network.
- 8) Set the login user name and password.
- 9) After logging in to the platform, you can implement video surveillance, search videos, and make a call.

### 4.1 Installing the MDVR

- (1) Loosen the screws, insert the key to open the hard disk lock, and pull out the hard disk. (If no hard disk is installed into the MDVR, install a hard disk by yourself.)



(2) Open the upper cover of the disk enclosure by using a screwdriver, and then install a hard disk.

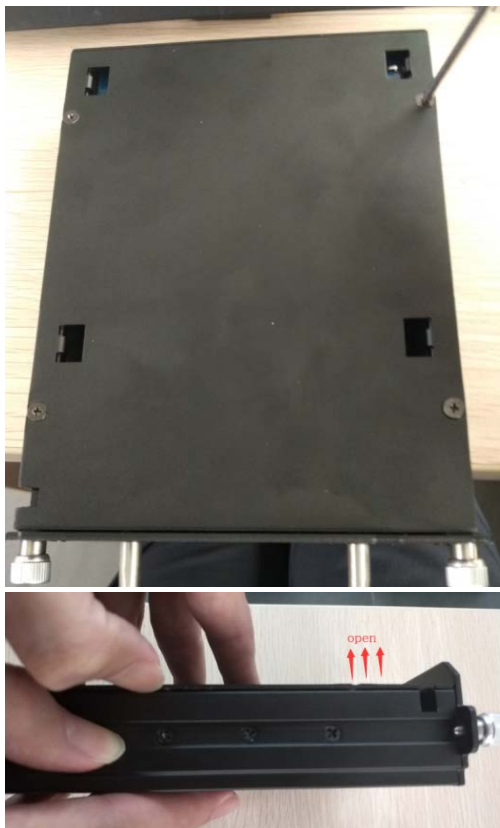

After opening the disk enclosure, you will see the SATA interface that is used to connect a 2.5-inch hard disk.

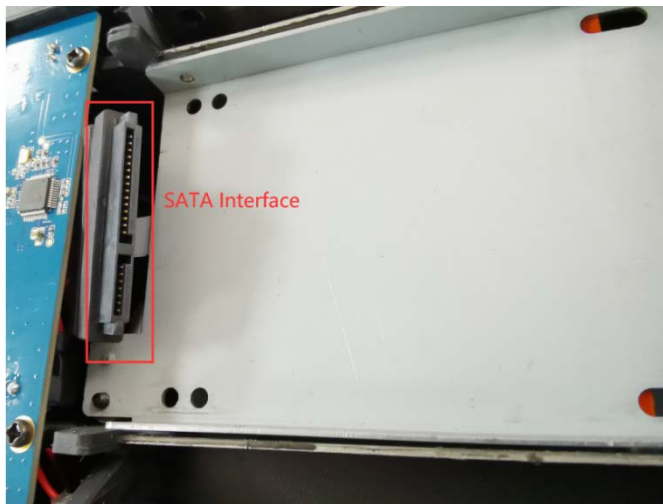

After installing the hard disk, fix the hard disk with your thumb, turn the disk enclosure over, and tighten the screws firmly.



Tighten the eight screws on both sides of the disk enclosure, and install the disk enclosure.

(3) Install a SIM card and a SD card, and then lock the hard disk. **(Note: You must use the key to lock the hard disk after putting the hard disk back. Otherwise, the MDVR cannot be started.)**



(4) Connect eight cameras, the display, handset, GPS antenna, GSM antenna, WiFi antenna, and power cable.

Plug the power cable into the PWR interface.

Connect cameras 1–8 to AV-IN1–8 interfaces respectively.

Connect the display to the AV-OUT interface or the handset to the MIC&SPK interface.

Connect the WiFi antenna, GPS antenna, and 3G/4G antenna to the MDVR. (If the WiFi antenna is not connected, the WiFi function will be unavailable.)

(5) Supply power to the MDVR and connect the external power supply to the ACC cable. (**Note: To enable the recording function, ensure that the ACC cable is connected to the positive terminal of the power supply and the hard disk is locked.**)



(6) After the external power supply is connected, the initialized MDVR will automatically record videos, and the display will be turned on automatically and play live videos.



Note: There are two types of displays available, that is, the display with an AV-OUT interface and the display with a VGA interface. Users can select one or two displays as required.

## 4.2 Configuring the MDVR by Using Meitrack Manager

After the MDVR is installed, connect it to a network and server. You can configure the MDVR by using any of the following methods: Meitrack Manager software, SMS, and platform. In this section, I will show you how to use the Meitrack Manager software to fast configure the MDVR.



You need to install Meitrack Manager first. (Visit [www.meitrack.com](http://www.meitrack.com) to download the software; software version: 6.0.2.0 later). After the installation is completed, connect the USB cable to a computer, and then perform the following steps to configure the MDVR.

(1) After the MDVR is installed, connect it to the network and server. You can configure the MDVR by using any of the following methods: Meitrack Manager software, SMS, and platform.

Set the IP address and port for uploading positioning data, IP address and port for uploading video data, and the user name and password of the FTP server:

GPRS Tracking

Para Setting

GPRS  Close  TCP  UDP

IP/Domain  Port

Backup IP/Domain  Port

GPRS Timezone(mins)

SMS configuration:

Send the following command to set the IP address and port for uploading positioning data:

0000,A21,1,67.203.15.7,50005,APN(for example, internet),APN\_USER,APN\_PASSWORD.

(2) Set the IP address of the FTP server. Video data will be uploaded to the specified FTP server.

FTP Setting

FTP Enabled

IP/Domain  Port

User Name  Password

Remote Directory

Maximum File Size(MB)

(3) Set the network.

There are three network connections: cellular network (3G/4G), WiFi, and Ethernet. Ethernet is the best choice, WiFi is the second choice, and a cellular network is the last choice. It means that if the MDVR is connected to Ethernet, the WiFi and cellular network will be disabled.

WiFi configuration:

As shown in the following figure, enter the WiFi SSID and password and click **Set**. The WiFi network connection is set successfully.

You can click **Refresh** to search the WiFi list nearby.

Wi-Fi Settings

Wi-Fi Mode

SSID

Key

Nearby WiFi List

- Meitrack\_GuoJi
- Meitrack\_XingZheng
- Meitrack\_Meeting
- ChinaNet-669F
- CMCC-h7yr
- ChinaNet-5qtM
- Four Points by Sheraton
- Four Points by Sheraton

Ethernet configuration:

Enter the IP address, subnet mask, gateway, active DNS server and standby DNS server.

Ethernet Settings

IP Address

Subnet Mask  Preferred DNS Server

Default Gateway  Alternate DNS Server

Cellular network configuration:

Enter the APN, APN user name and APN password, and click **Set** to save the settings.

PPPoE Settings

APN

User Name

Password

**Set**

(4) Check whether the hard disk or SD card is installed properly. When you use the MDVR for the first time, if the system detects format errors, the SD card or hard disk will be initialized automatically. If "no error" is displayed as follows, it means that the SD card or hard disk is initialized successfully.

Disk	Driver Type	Current Disk	Free Space(MB)	Capacity(MB)	Free Space(%)	Error Flag	Driver Serial Number	Format Hard Disk
Disk1	Read-write	<input type="checkbox"/>	57236	57241	99.99%	No error	2	Format
Disk2	Read-write	<input checked="" type="checkbox"/>	41554	60905	68.23%	No error	3	Format

### 4.3 Logging In to the Platform

Visit <https://mdvr.trackingmate.com/>, enter the user name and password, and log in to the platform.

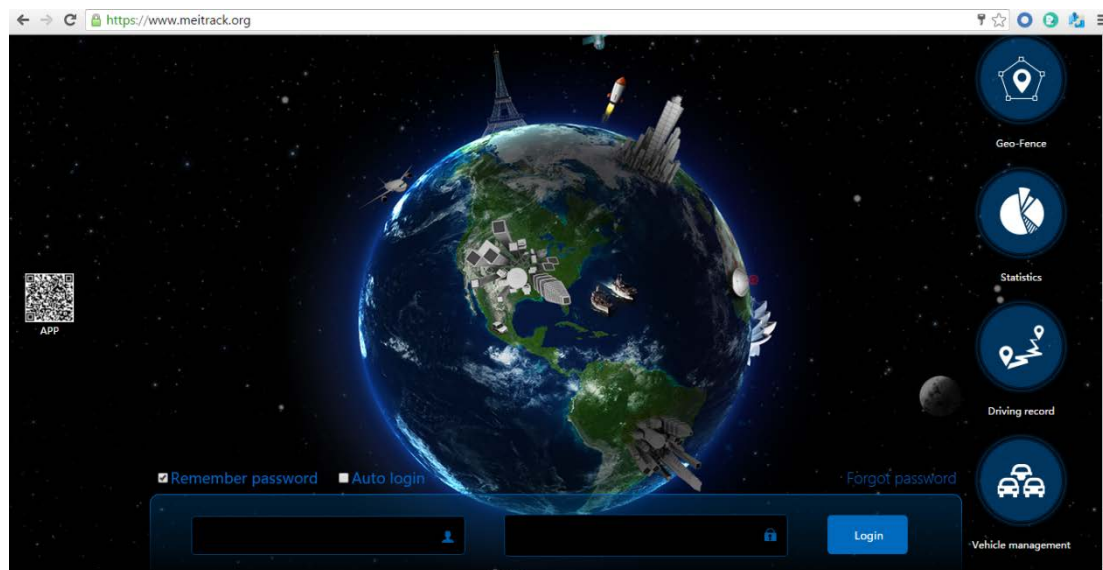

#### Add a MDVR:

1. On the main interface, choose **Management**. On the page that is displayed, select **Account & Tracker** from **Use Normal**.
2. On the **Account/Tracker Management** window, right-click a user, and select **Add new tracker**.
3. On the **Add new tracker** window, enter related information, modify the expiry date, and click **Submit**.

Note: The IMEI number must be consistent with that printed on the MDVR. Otherwise, the MDVR cannot be detected by the system.



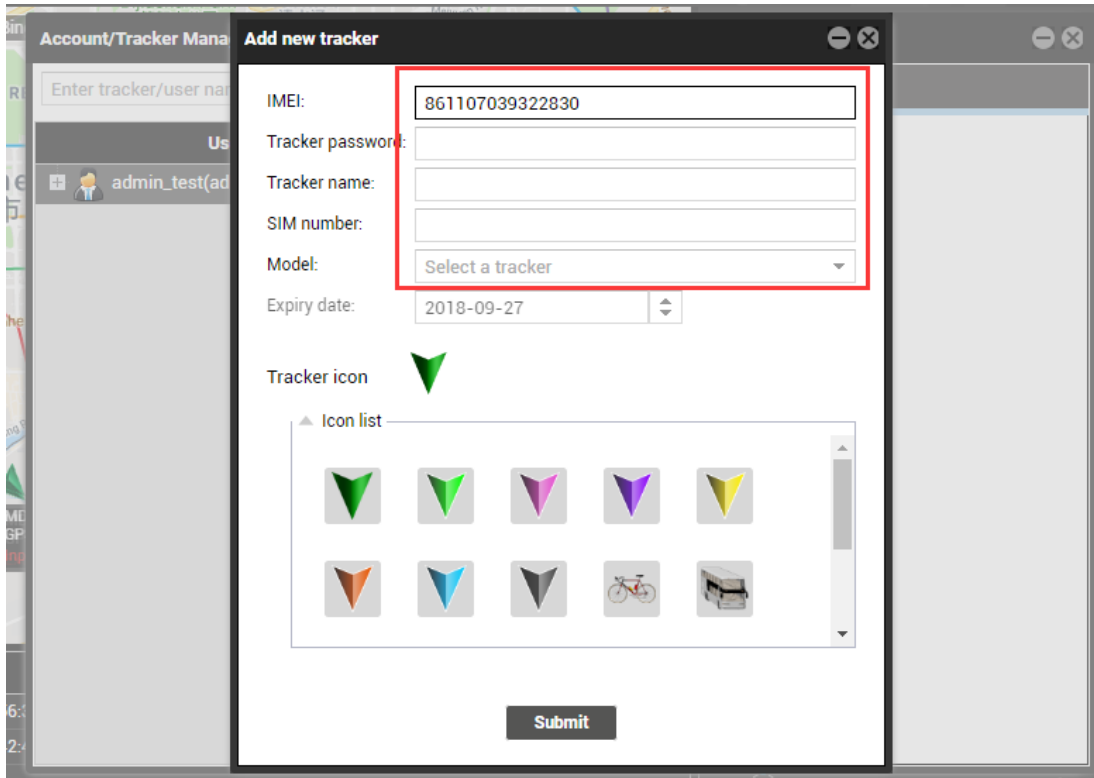
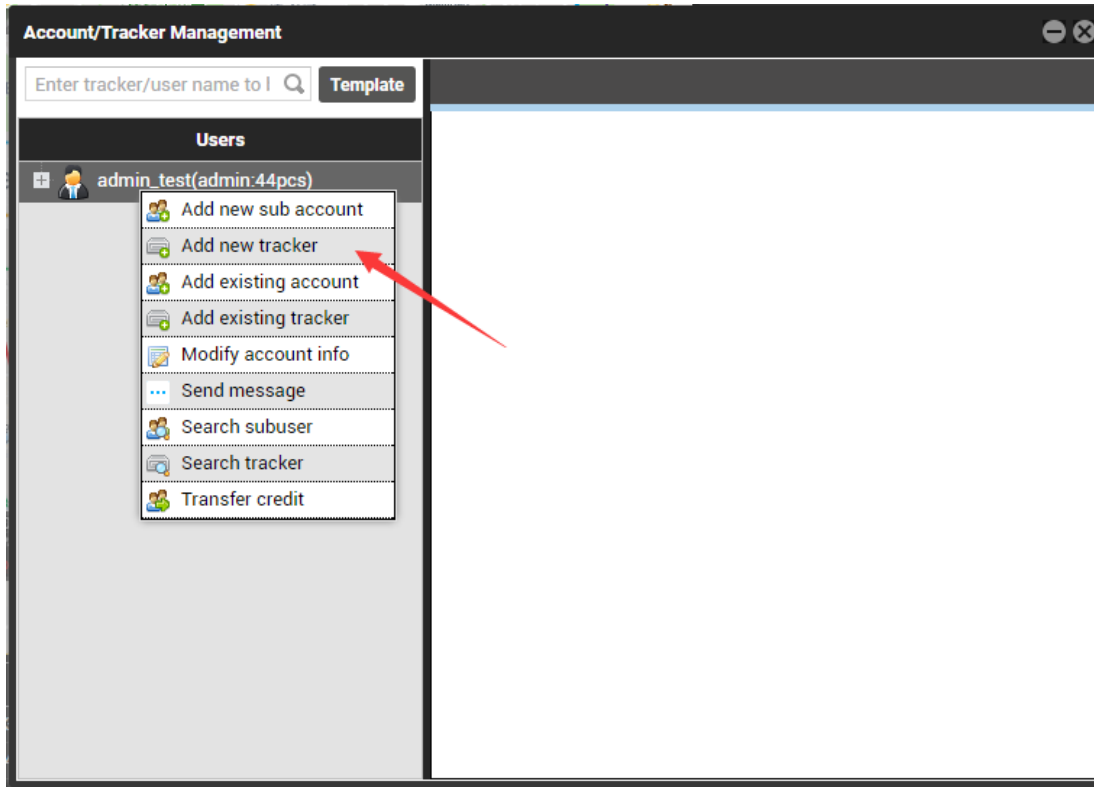

**Check whether the MDVR is online:**

If the green signal icon  is displayed, it means that the MDVR is online.

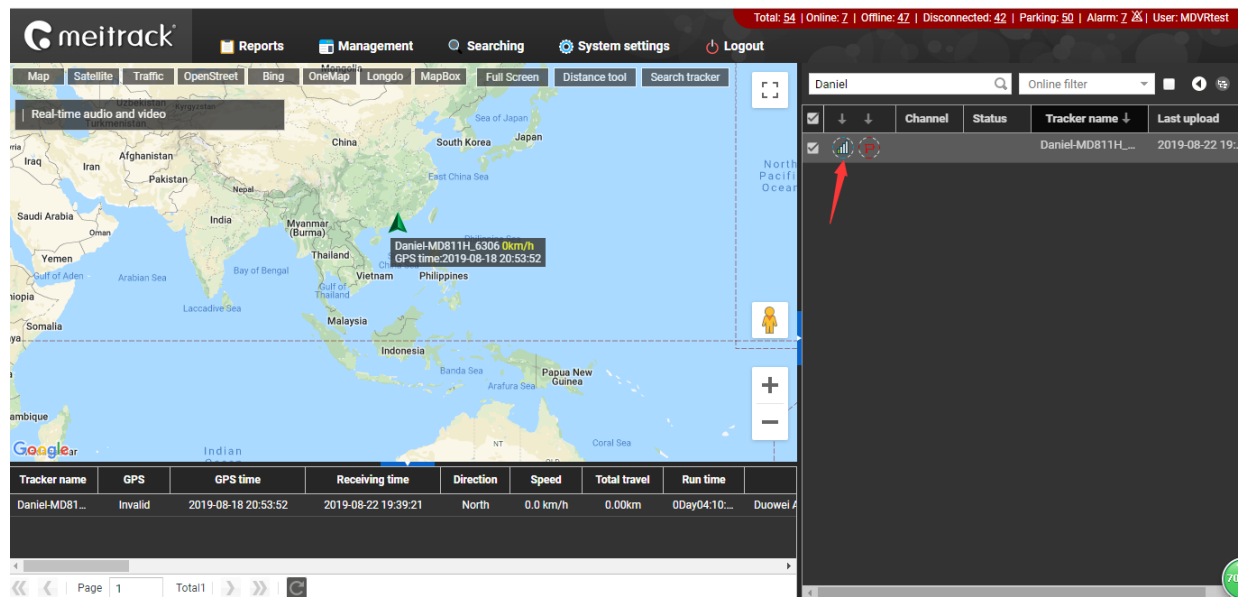

**Video surveillance:**

Right-click a MDVR and select **Video Monitor** to start all-channel surveillance.

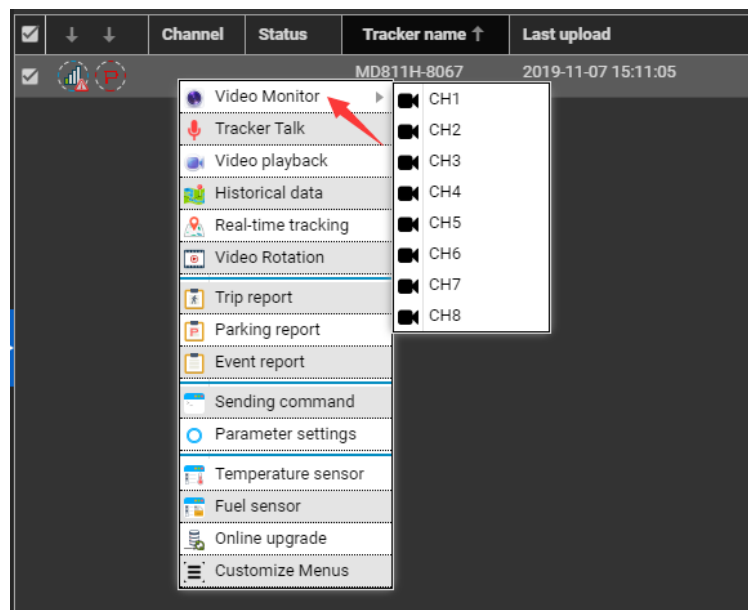

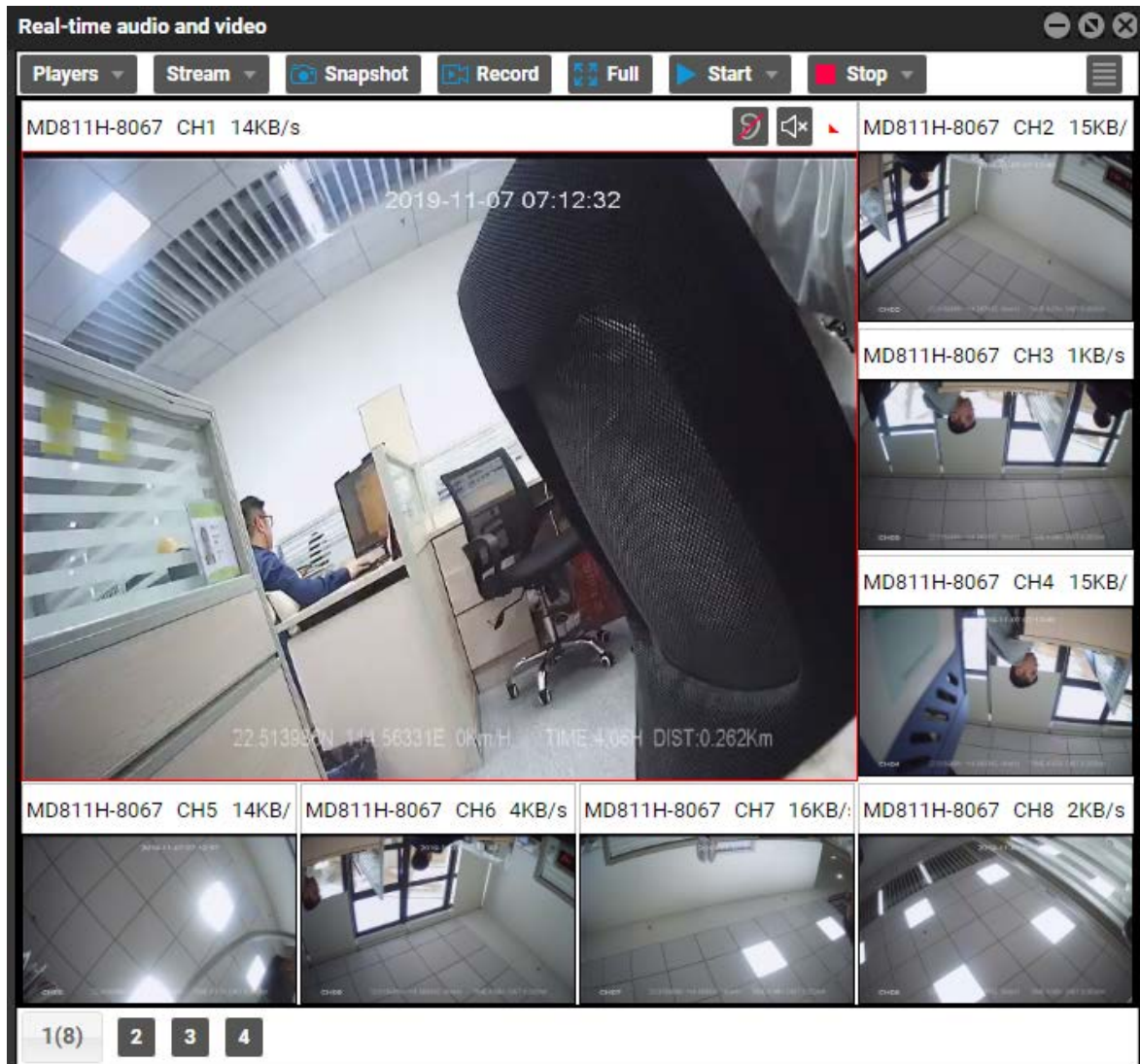

If a single channel is selected, such as CH1, videos in this channel will be played.

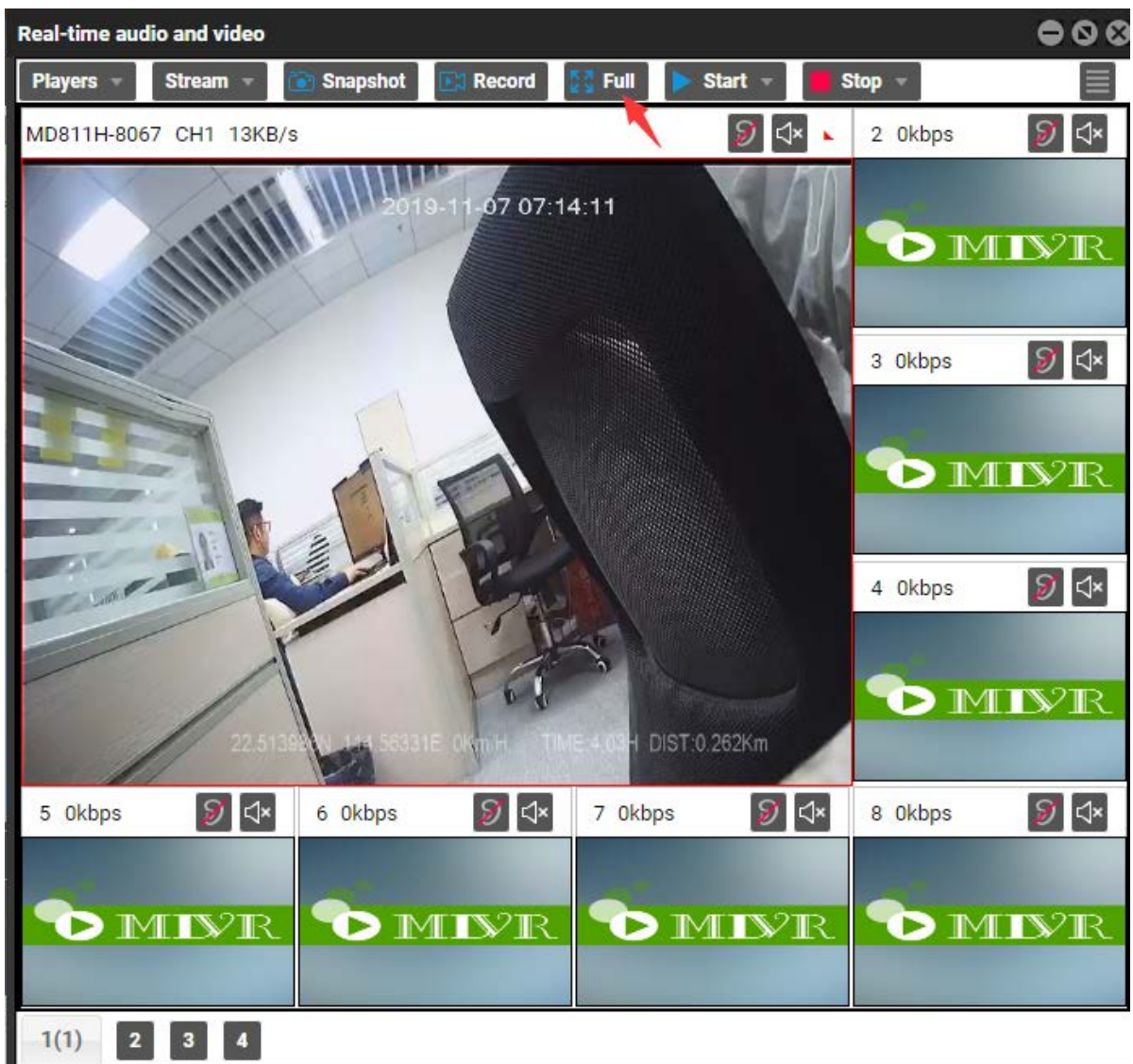
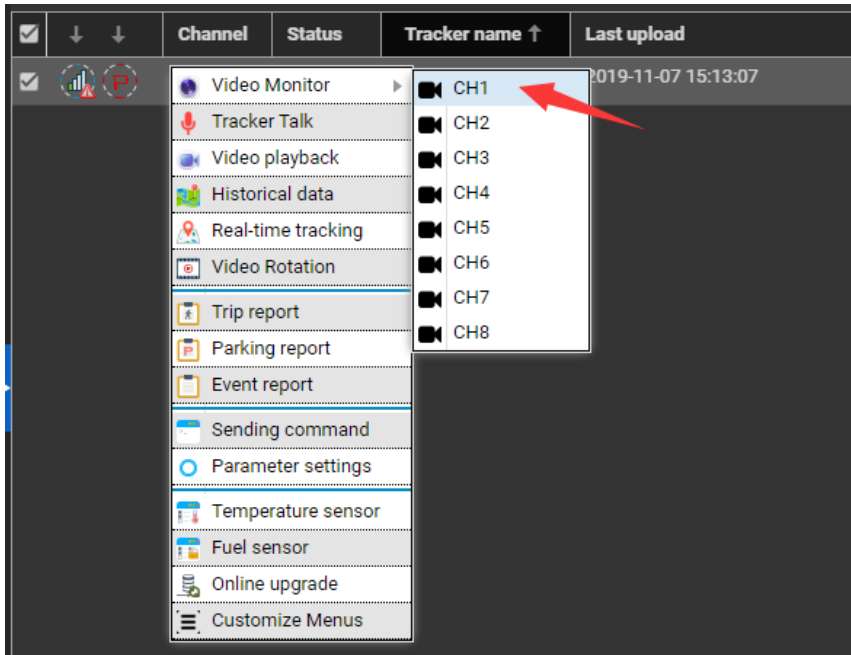

**Video playback and search:**

Right-click a MDVR and select **Video playback**. On the page that is displayed, set **Start time**, **End time** and **Channel**, and click **Search**. The video playback will start.

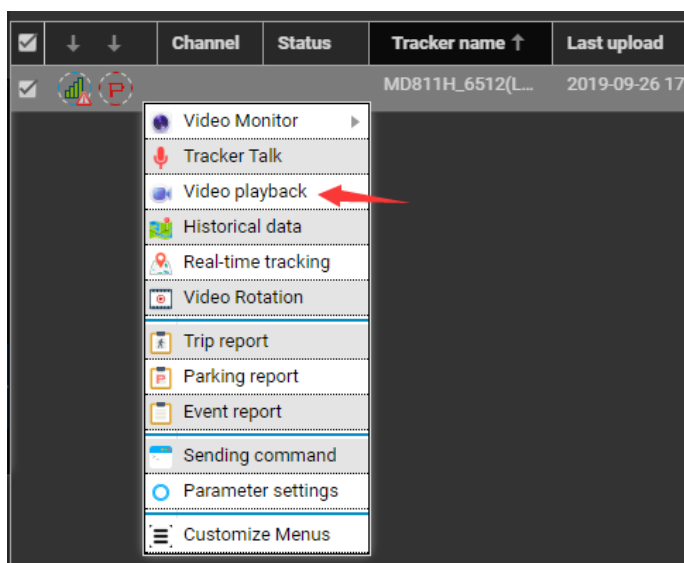

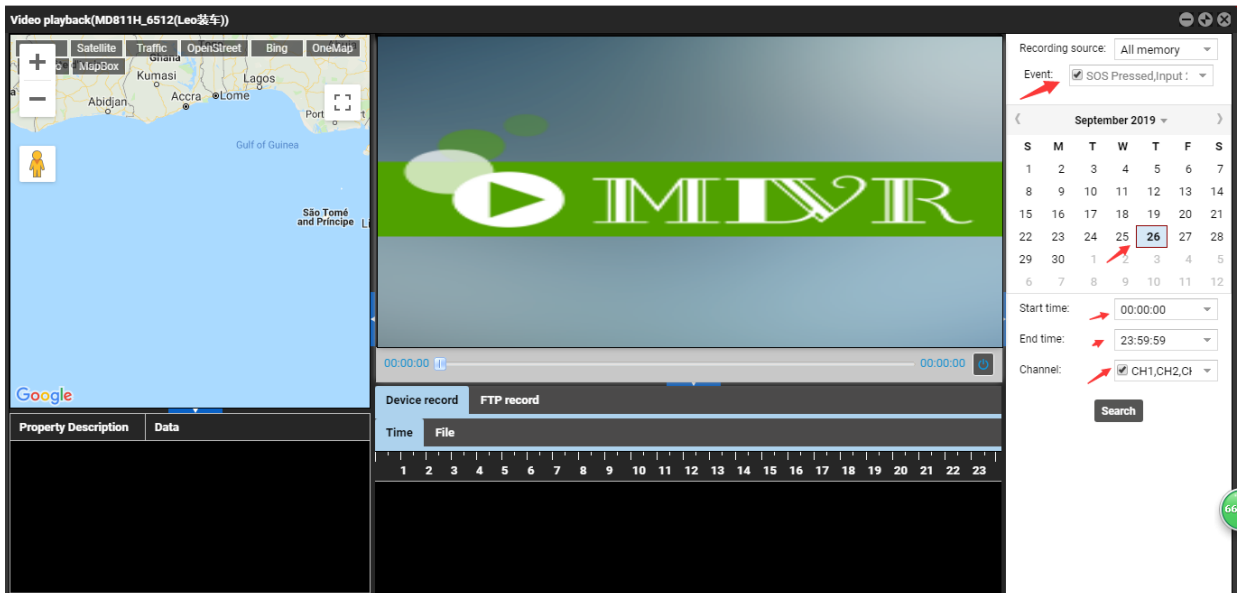

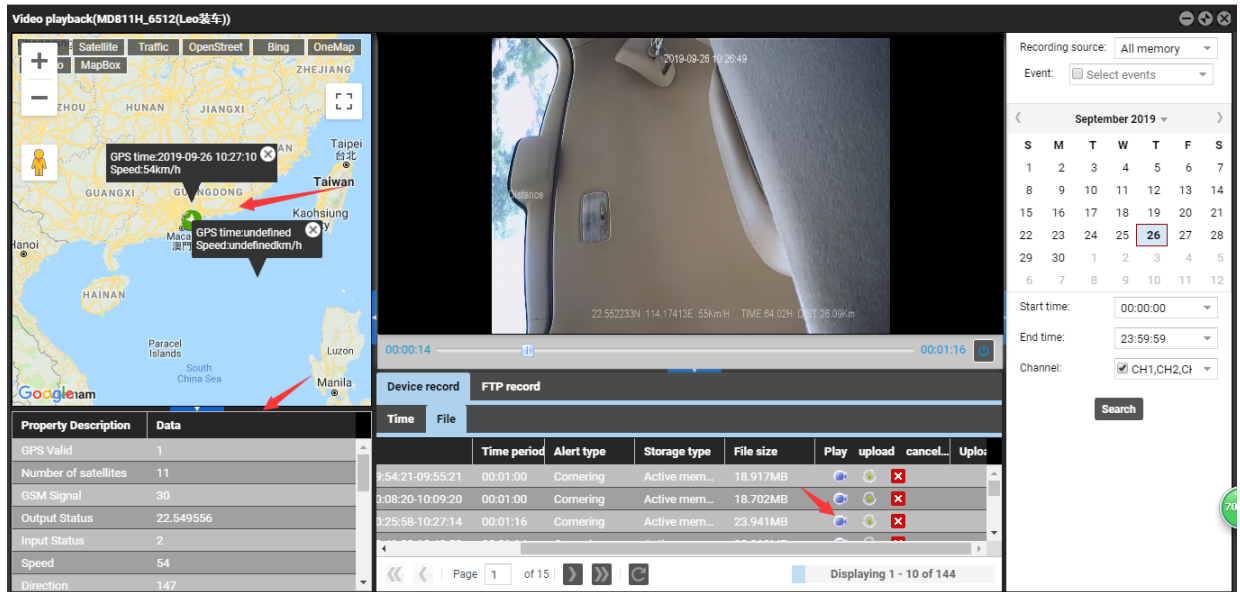

While playing back video files, the location information of related images will be displayed and travel routes will be played. As shown in the previous figure, the icon in the **Play** column is used to play the current video, the icon in the **Upload** column is used to upload the current video file to the FTP server, and the icon in the **Cancel** column is used to stop uploading the video file.

**Query historical positioning data:**

Right-click a MDVR and select **History data report**. On the page that is displayed, click the map icon . The device's travel routes will be displayed.

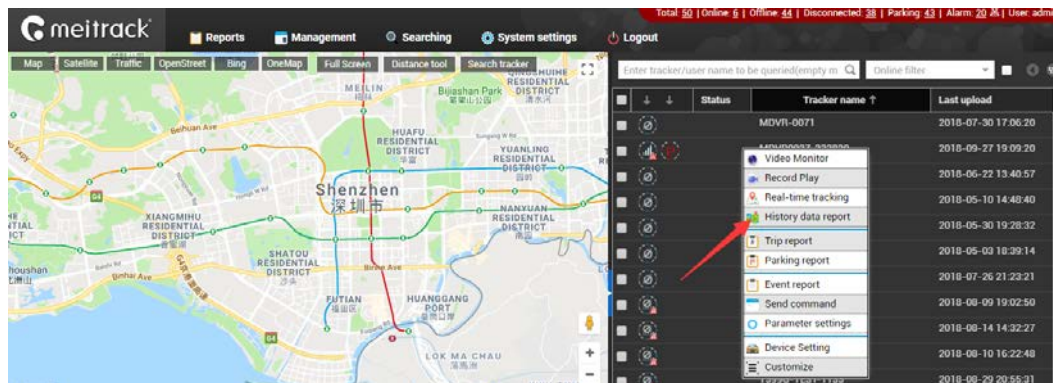

MDVR0927-322830

From: 2018-09-27 00:00 To: 2018-09-27 23:59 Speed: 0 Address:  Ignore drift

Tracker name	GPS time	Receiving time	GPS valid	Speed	Latitude	Longitude	Location	Alarm type	Altitude	Direction	North An	Number of satell
MDVR0927-322830	2018-09-27 15:57:47	2018-09-27 15:57:46	Valid	0	22.513301	114.057006		Track By Time Interval	90	North	0	5
MDVR0927-322830	2018-09-27 15:57:49	2018-09-27 15:57:52	Valid	0	22.513301	114.057008		Exit GPS Blind Spot	92	North	0	5
MDVR0927-322830	2018-09-27 15:57:52	2018-09-27 15:58:10	Valid	0	22.513305	114.057003		CH2 video loss	93	North	0	5
MDVR0927-322830	2018-09-27 15:57:57	2018-09-27 15:58:14	Valid	0	22.513301	114.057001		Track By Time Interval	95	North	0	5
MDVR0927-322830	2018-09-27 15:58:07	2018-09-27 15:58:17	Valid	0	22.513275	114.057025		Track By Time Interval	97	North	0	5
MDVR0927-322830	2018-09-27 15:58:17	2018-09-27 15:58:22	Valid	0	22.513240	114.057053		Track By Time Interval	99	Sout...	147	5
MDVR0927-322830	2018-09-27 15:58:27	2018-09-27 15:58:23	Valid	0	22.513241	114.057053		Track By Time Interval	99	Sout...	149	5
MDVR0927-322830	2018-09-27 15:58:37	2018-09-27 15:58:36	Valid	0	22.513246	114.057050		Track By Time Interval	99	Sout...	150	5
MDVR0927-322830	2018-09-27 15:58:47	2018-09-27 15:58:52	Valid	0	22.513236	114.057053		Track By Time Interval	99	Sout...	150	5
MDVR0927-322830	2018-09-27 15:58:57	2018-09-27 15:58:58	Valid	1	22.513235	114.057053		Track By Time Interval	99	Sout...	150	5
MDVR0927-322830	2018-09-27 15:59:07	2018-09-27 15:59:31	Valid	0	22.513235	114.057045		Track By Time Interval	99	Sout...	150	5

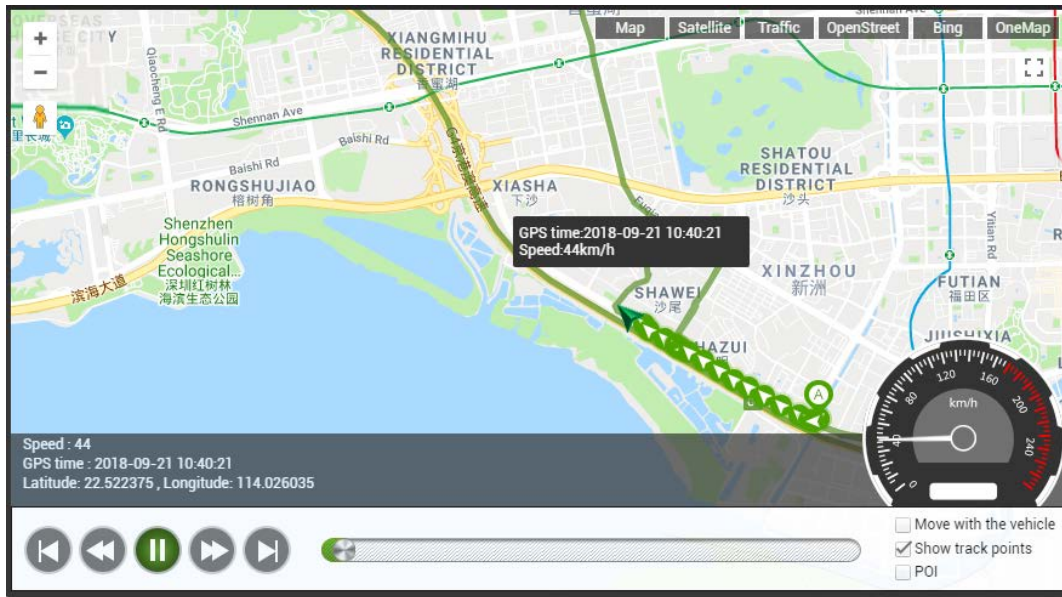

## 5 Configuring the MDVR by Using the LAN Web Page

(If you want to know how to use the function, please see the *Meitrack MDVR Operation and Function Manual*.)

You can use the LAN to configure the MDVR. There are two methods as follows:

- 1) Connect the computer and MDVR to the same WiFi hotspot, and then configure the MDVR on the web page.
- 2) Connect the MDVR to the Ethernet, ensure that the computer and MDVR are in the same LAN, and then configure the MDVR on the web page.

You need to obtain the IP address of the LAN connected to the MDVR. (To obtain the IP address, you can connect the MDVR to Meitrack Manager to check the network status, send a command to query the network status, or contact the LAN administrator.)

After entering the MDVR IP address in the address bar of your web browser, you can configure the MDVR on the web page.

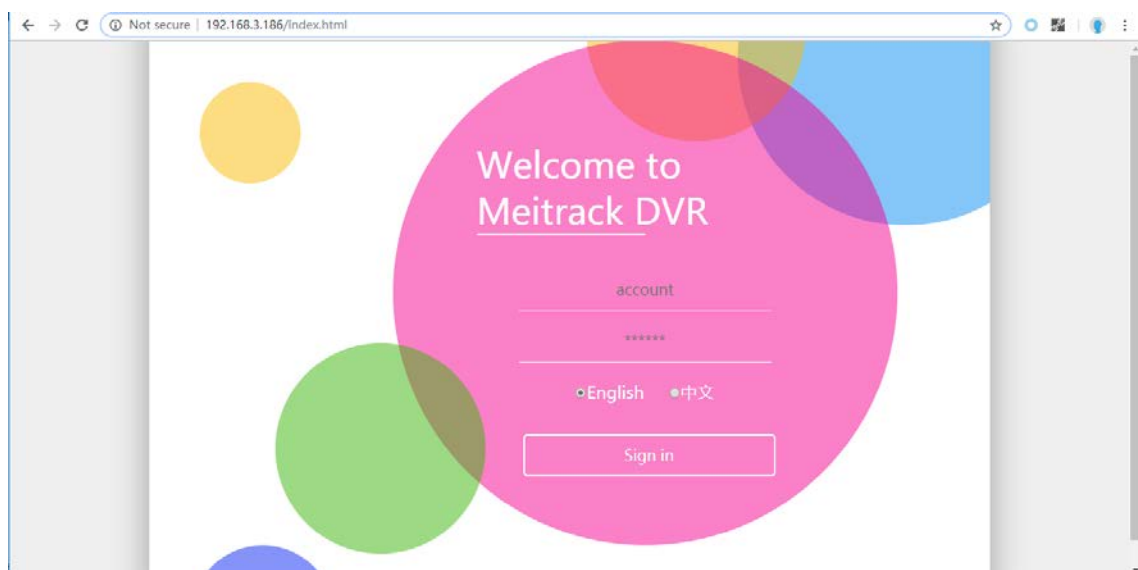

On the web page that is displayed, enter the user name and password (default user name: admin; default password: 0000), and



log in to the system. Then configure the MDVR on the web page. The configuration method is similar to that of Meitrack Manager.

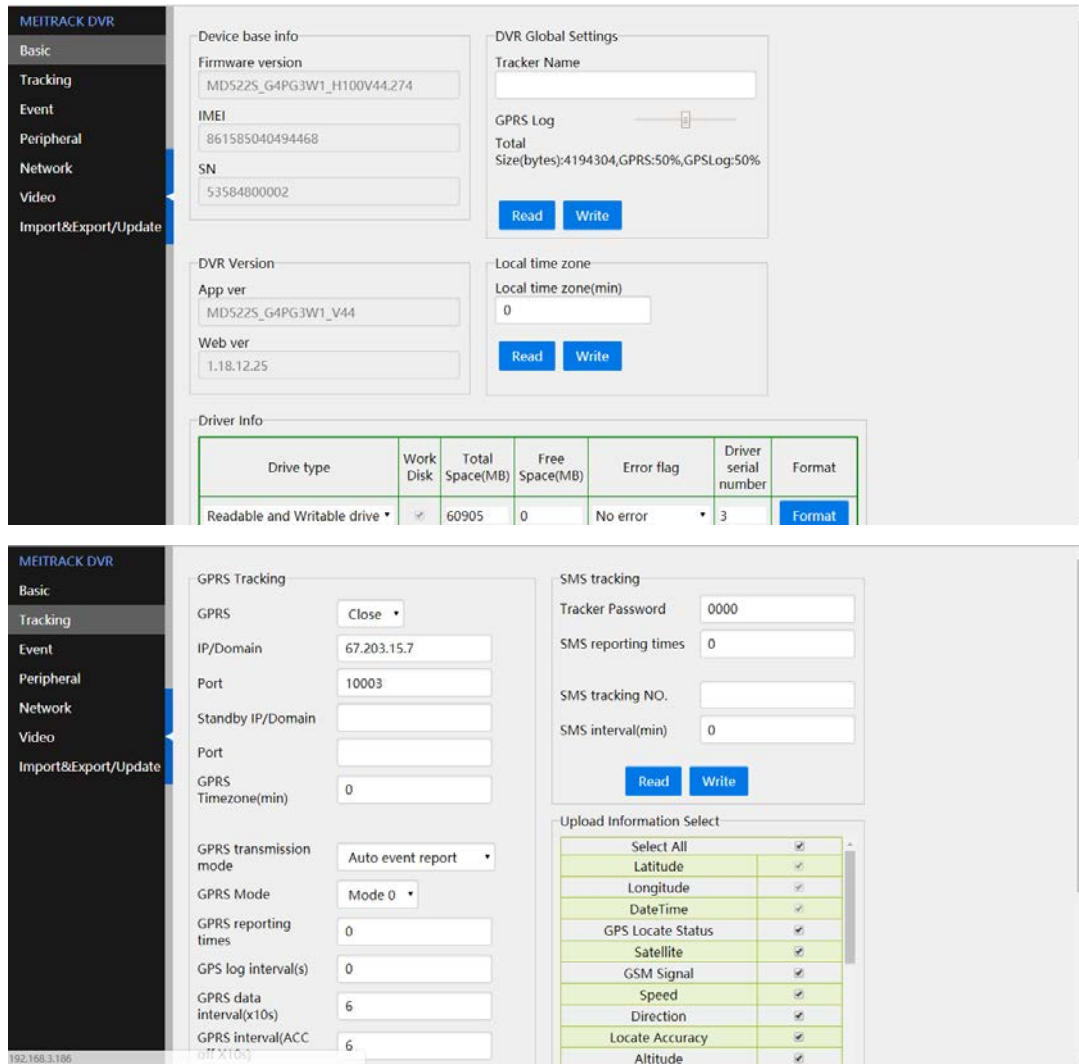

## 6 MS03 Web Platform

(If you want to know how to use the platform, please see the *Meitrack MDVR Operation and Function Manual*.)

You can visit [mdvr.trackingmate.com](http://mdvr.trackingmate.com) and log in to the MS03 platform. On the platform, live streams of the MDVR can be loaded (real-time monitoring), and recording files can be stored (large files are stored on the FTP server).

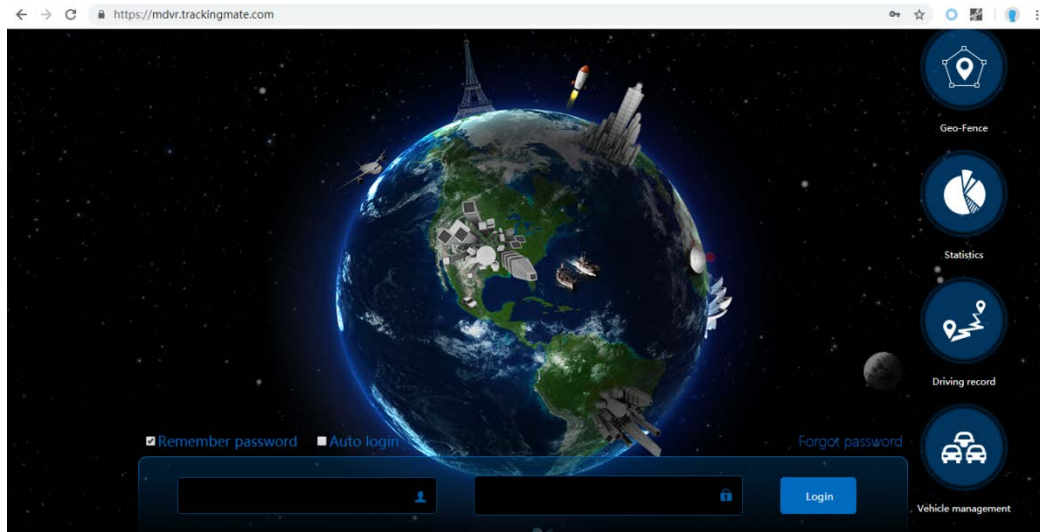

After logging in to the platform and adding the MDVR, you can use the positioning function, monitor the MDVR in real time, play back videos, query alert videos, and make a call.

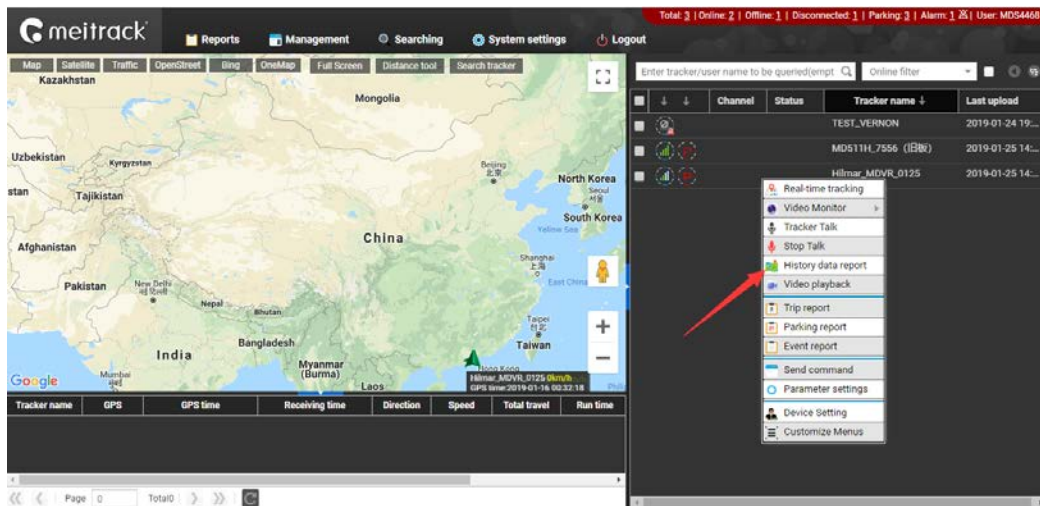

## 6.1 Real-time Monitoring

Right-click the MDVR, and select **Video Monitor** and a camera surveillance channel to play videos.

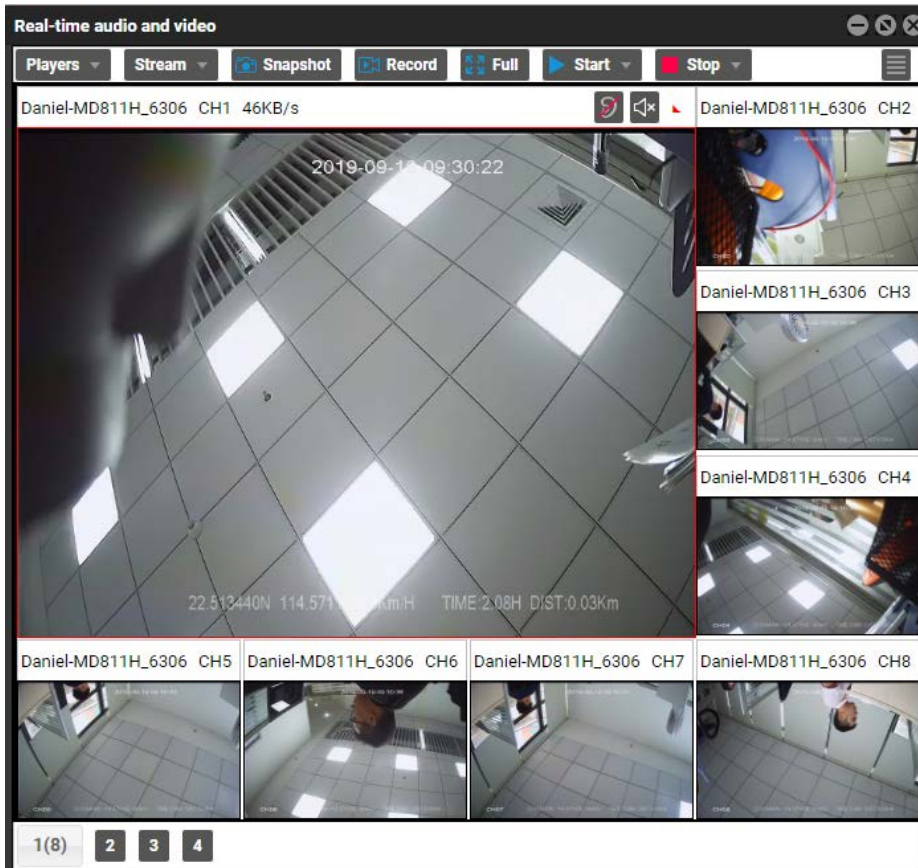
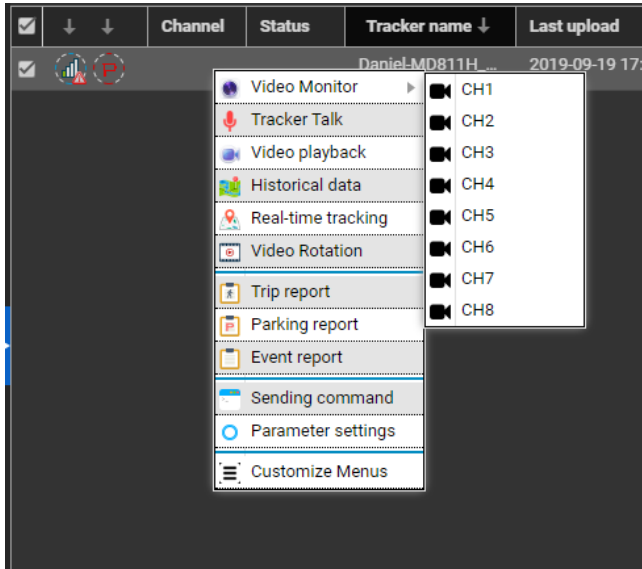

## 6.2 Video Playback

Right-click the MDVR and select **Video playback**.

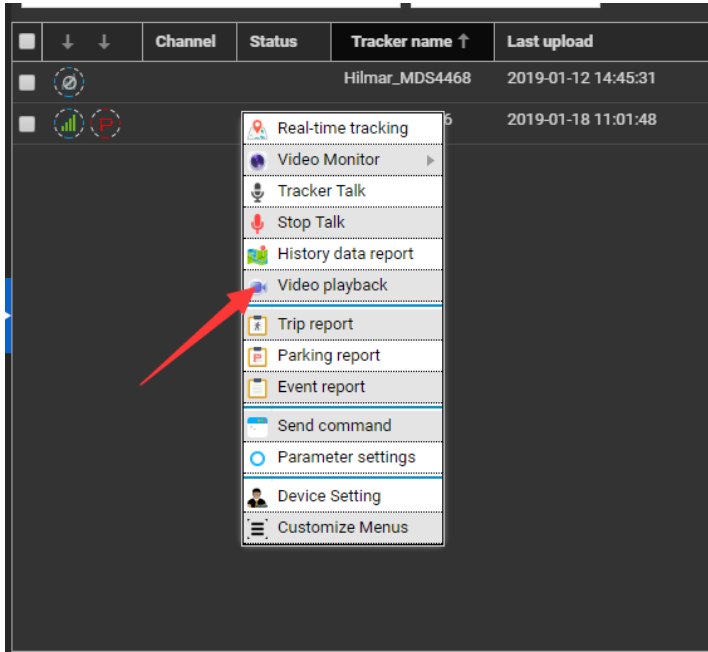

Select related videos based on events.

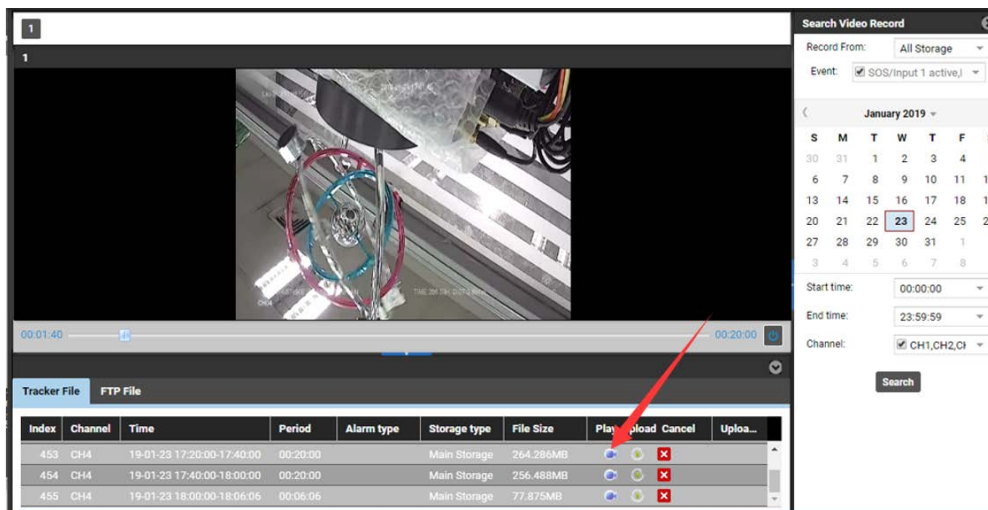
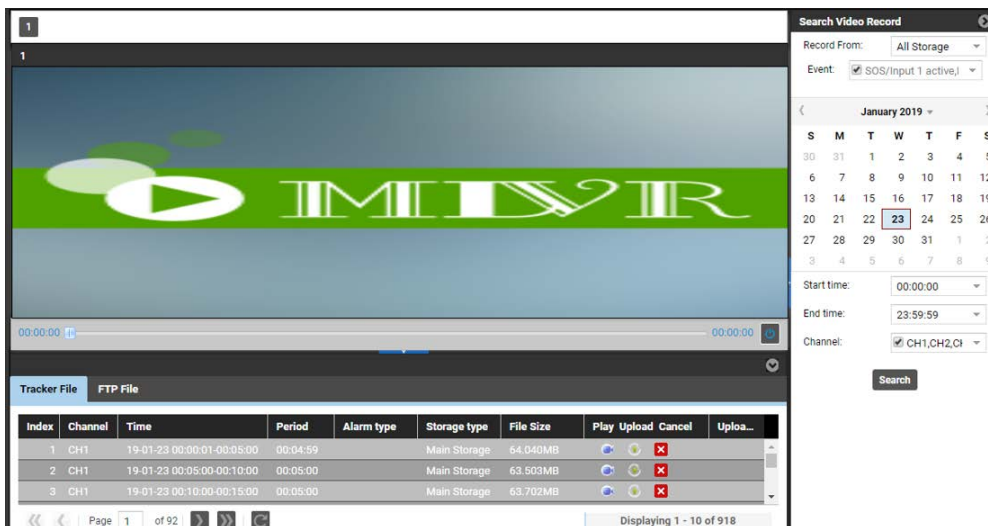

## 6.3 Two-Way Calling

Right-click the MDVR and select **Tracker Talk**.

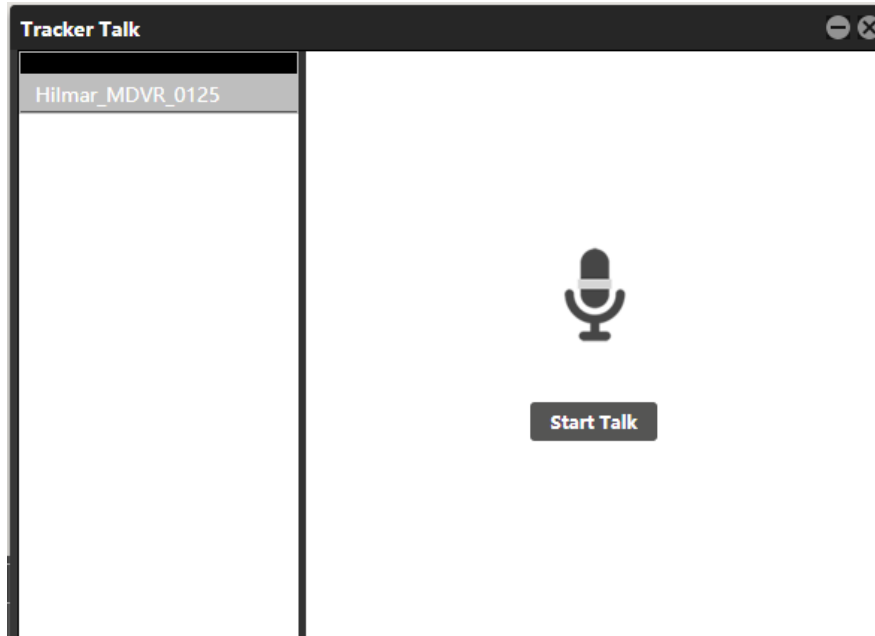
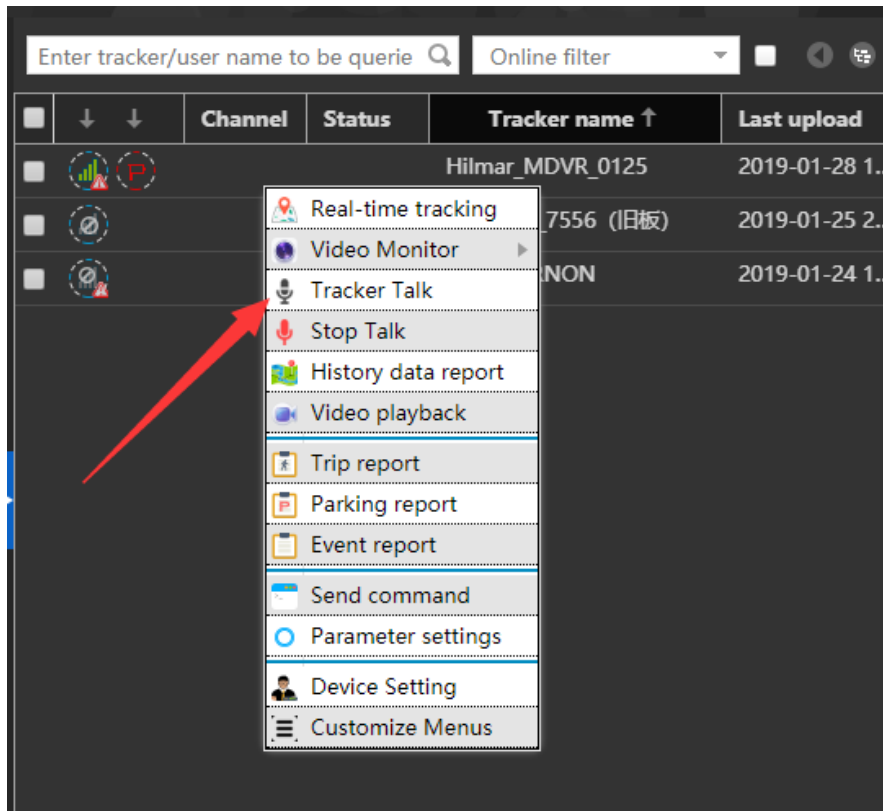

You can talk with multiple users.

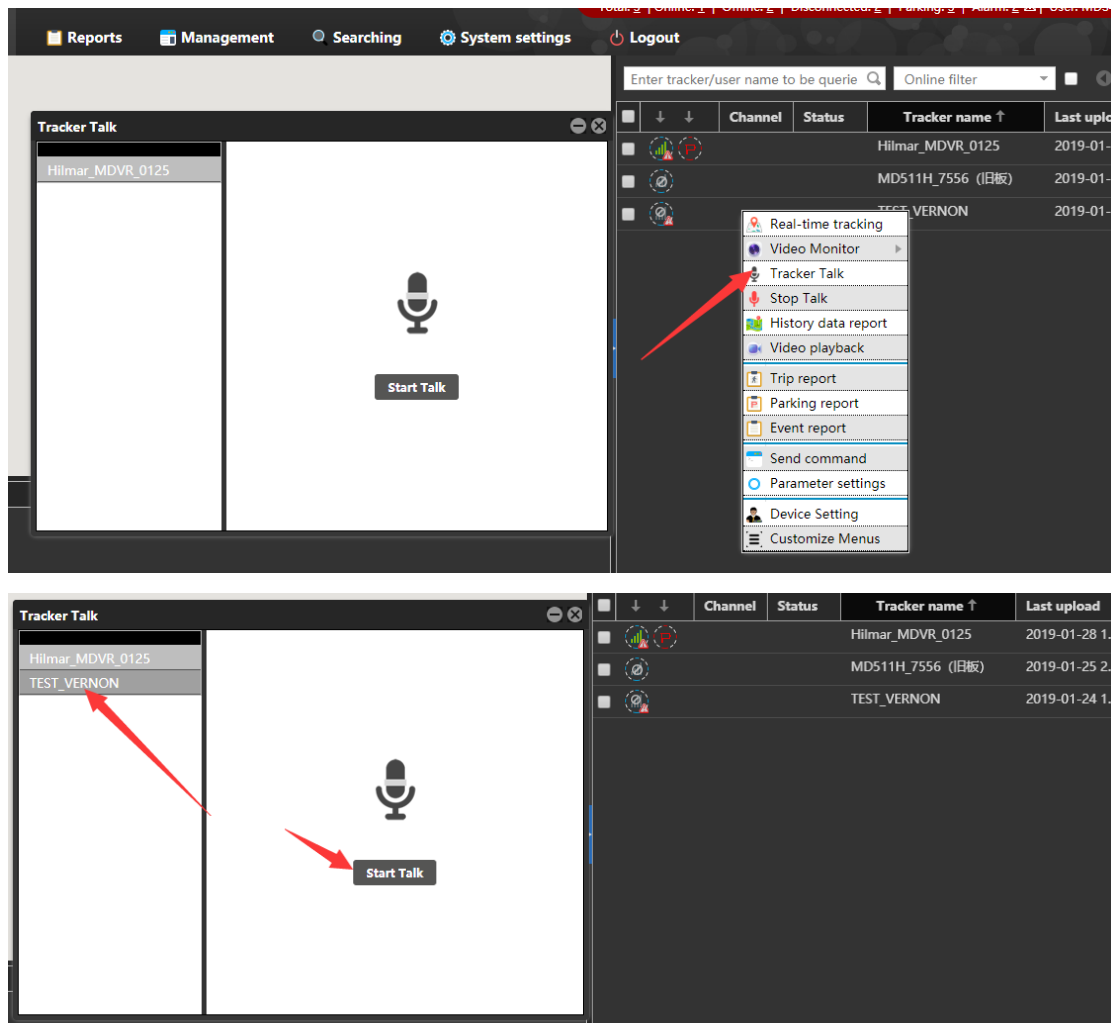

Select the users to call, and click **Start Talk** to start broadcasting.



Before a talk starts, MDVR users need to press and hold down the talk button at the left side of the MDVR. During broadcasting, a call can be made between platform users and MDVR users, while MDVR users cannot talk with each other.

## 7 MS03 App

### 7.1 Logging In to the App

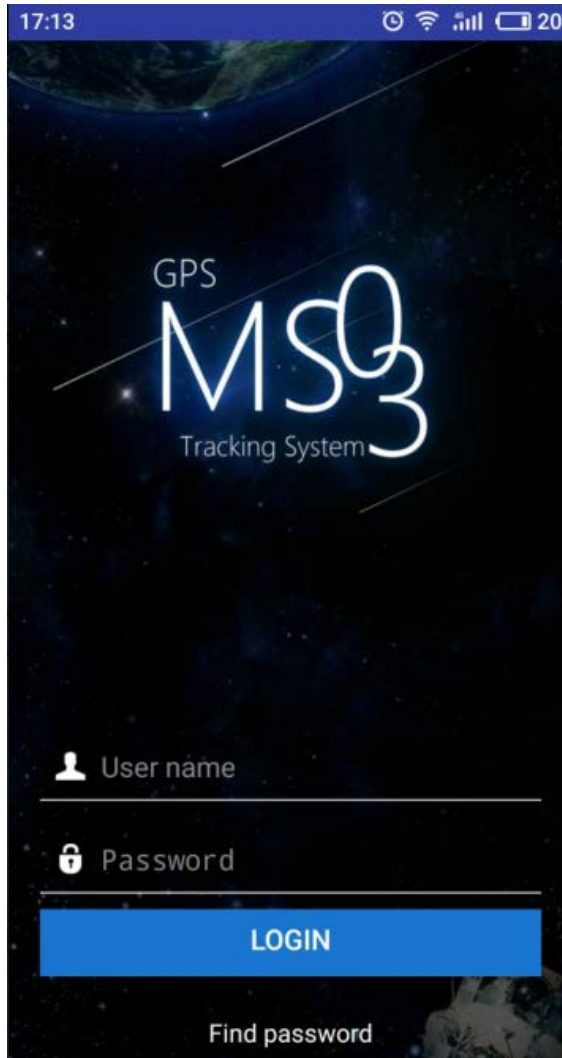

### 7.2 Checking MDVR Online Status

If the green signal icon  is displayed, it means that the MDVR is online.

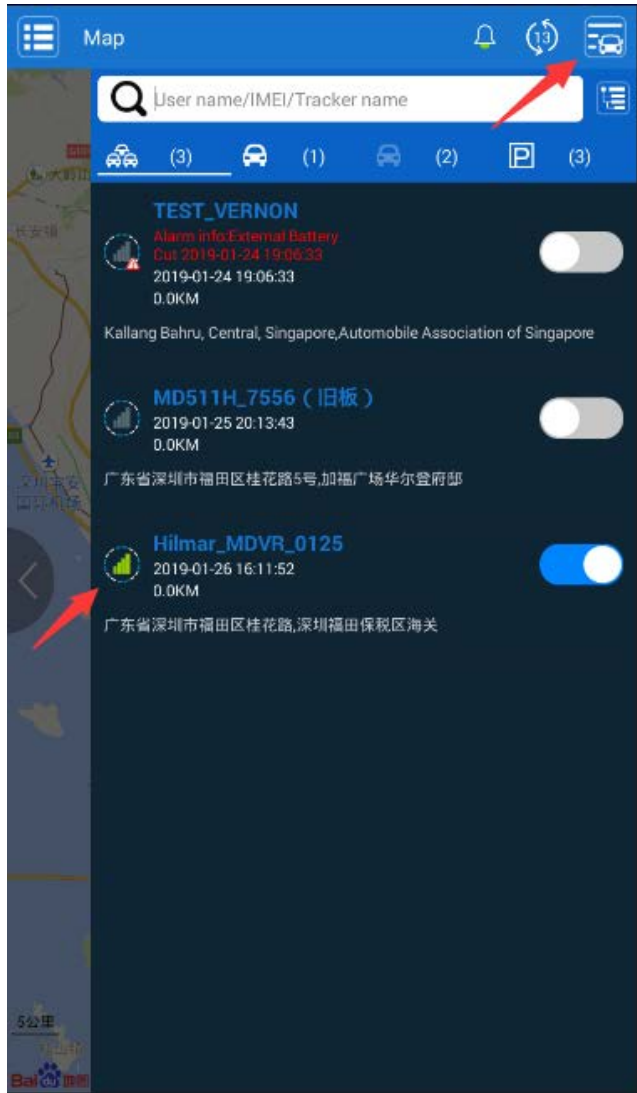



### 7.3 Video Surveillance

Click **MDVR** on the map, or choose **MDVR** on the **Management** page. Then the video surveillance page will be displayed.

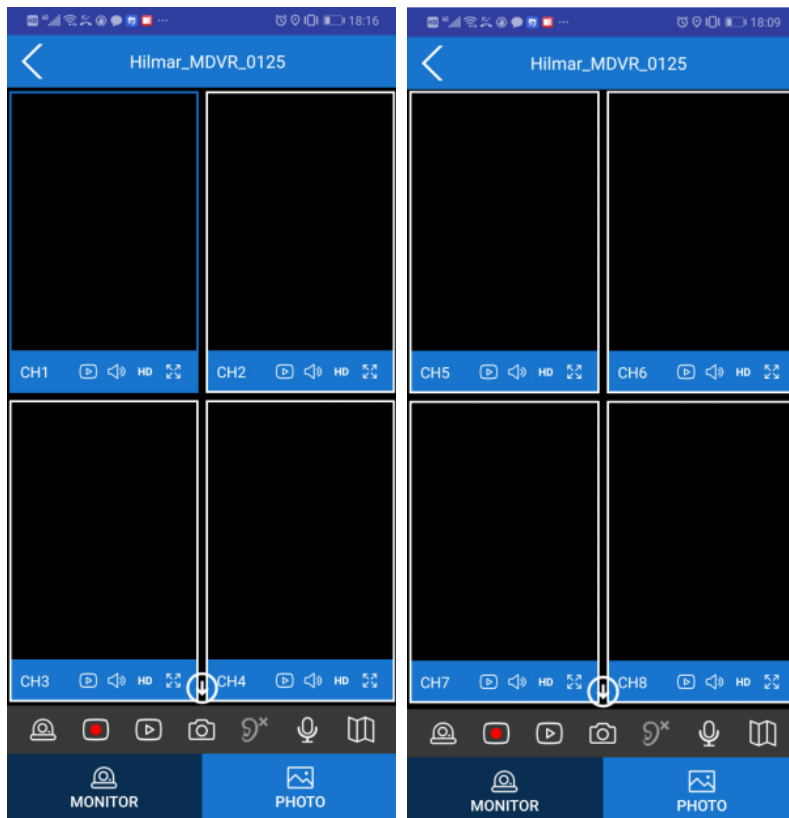
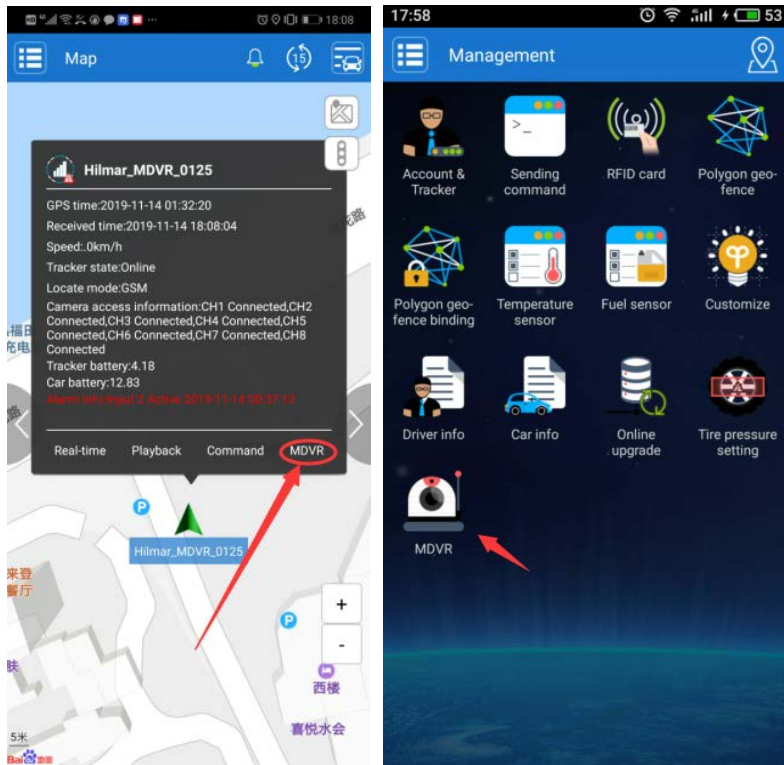



Click  to play videos of corresponding channel. Click  to start four-channel surveillance.

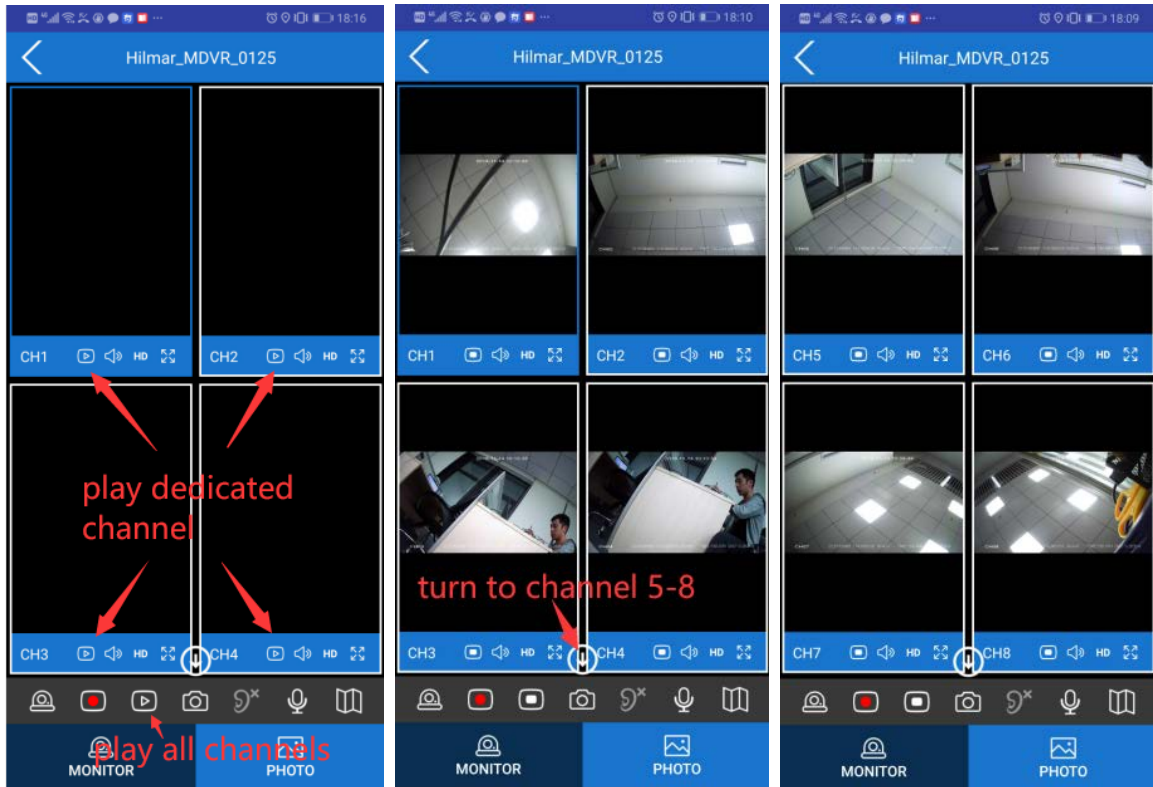

## 8 Playing MDVR Videos by Using MT Player Software

(If you want to know how to use the function, please see the *Meitrack MDVR Operation and Function Manual*.)

### 8.1 Installing MT Player

Unzip the file **MTPlayerSetup.rar**, and double-click the file **MTPlayerSetup.exe** to install the software according to the setup wizard.

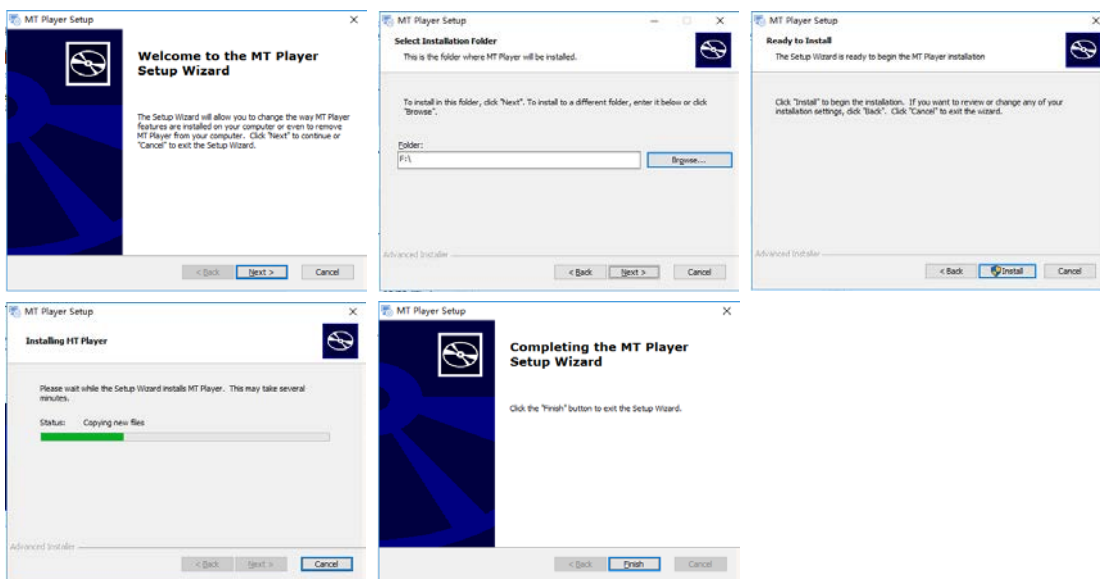

## 8.2 MT Player Functions

### 8.2.1 Querying GPS Positioning Data

After selecting a video on the following page, you can obtain the GPS positioning data generated during the video recording and export these data to an Excel file.

Note:

- GPS positioning data cannot be queried while videos are being played. Otherwise, an error warning will pop up.
- Recorded videos support two formats: **.avmsg** and **.mp4**. If you want to read GPS positioning data, you must select a video in **.avmsg** format.

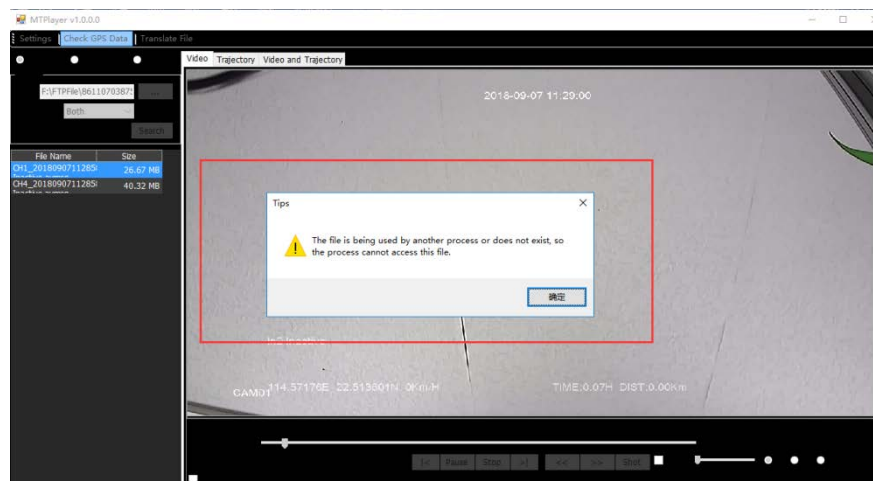

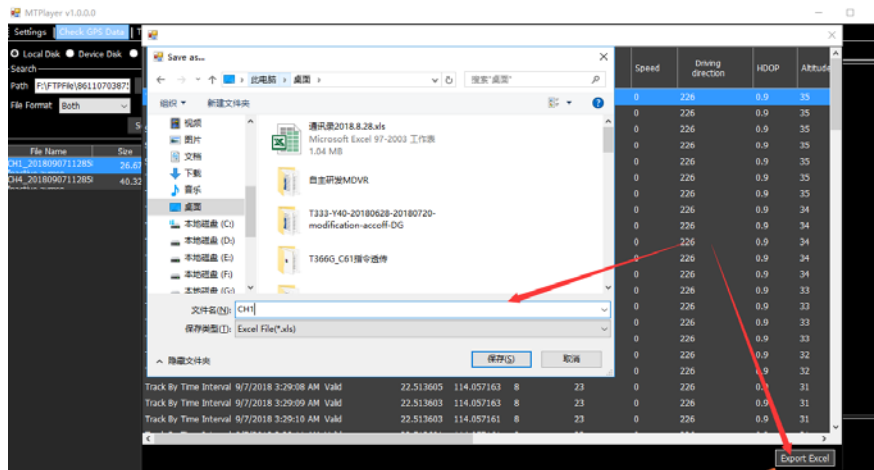

	Latitude	Longitude	Number of satellites	GSM signal strength	Speed	Driving direction	HDOP	Altitude	Mileage	Run time	Output port status	Input port status	ADT	AID2	AID3	Battery voltage	Extor
2	22.513600	114.057175	23	0	226	0	0.9	35	1965	0	2	1	1	0	422	2356	
4	22.513601	114.057176	23	0	226	0	0.9	35	1966	0	2	1	1	0	431	2356	
6	22.513601	114.057176	23	0	226	0	0.9	35	1966	0	2	1	1	0	431	2356	
7	22.513601	114.057176	23	0	226	0	0.9	35	1966	0	2	1	1	0	431	2356	
8	22.513601	114.057176	23	0	226	0	0.9	35	1966	0	2	1	1	0	421	2356	
9	22.513603	114.057173	23	0	226	0	0.9	35	1967	0	2	1	1	0	426	2356	
10	22.513603	114.057176	23	0	226	0	0.9	34	1968	0	2	1	1	0	425	2356	
11	22.513606	114.057178	23	0	226	0	0.9	34	1969	0	2	1	1	0	425	2326	
12	22.513603	114.057175	23	0	226	0	0.9	34	1970	0	2	1	1	0	422	2356	
13	22.513601	114.057175	23	0	226	0	0.9	34	1971	0	2	1	1	0	422	2356	
14	22.513603	114.057173	23	0	226	0	0.9	34	1972	0	2	1	1	0	431	2325	
15	22.513603	114.057173	23	0	226	0	0.9	33	1973	0	2	1	1	0	421	2366	
16	22.513605	114.057170	23	0	226	0	0.9	33	1974	0	2	1	1	0	422	2356	
17	22.513605	114.057171	23	0	226	0	0.9	33	1975	0	2	1	1	0	421	2356	
18	22.513605	114.057170	23	0	226	0	0.9	33	1976	0	2	1	1	0	425	2326	
19	22.513605	114.057168	23	0	226	0	0.9	32	1977	0	2	1	1	0	422	2326	
20	22.513605	114.057166	23	0	226	0	0.9	32	1978	0	2	1	1	0	421	2326	
21	22.513605	114.057163	23	0	226	0	0.9	31	1979	0	2	1	1	0	422	2326	
22	22.513603	114.057163	23	0	226	0	0.9	31	1980	0	2	1	1	0	425	2326	

## 8.2.2 Playing Videos

1. Play videos stored in local disks.

Locate a video in **.avmsg** or **.mp4** format on local disks of your computer.

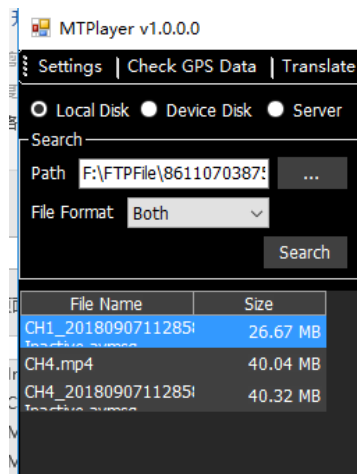

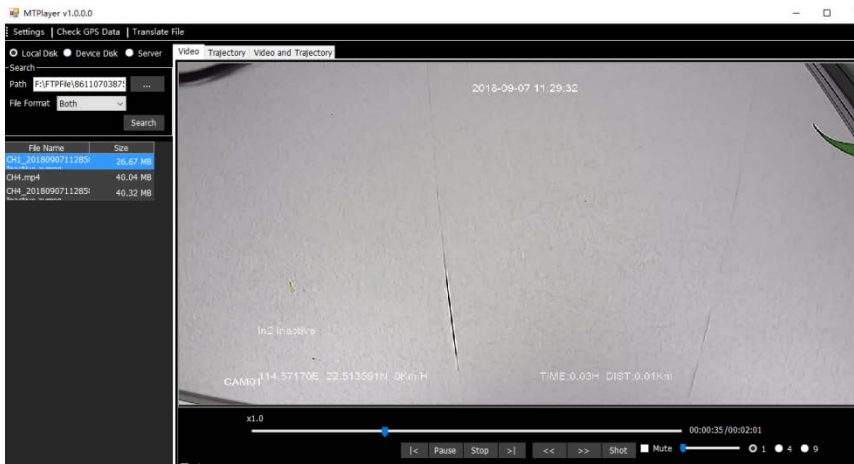

2. Play videos stored in a storage disk of the MDVR.

If related video file is detected from a storage disk of the MDVR by MT Player, the icon  will be displayed. If a black bold date appears on the calendar, it means that there are videos recorded on that day.

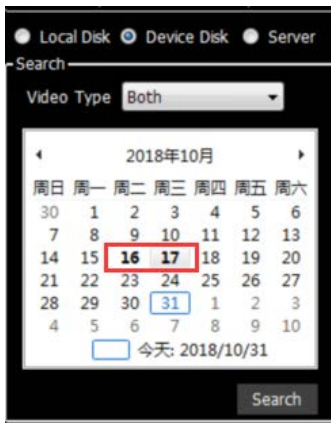

You can select **Normal** to play a complete video or **Alarm** to play an alert video.

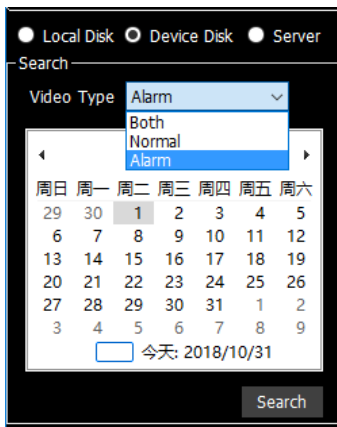

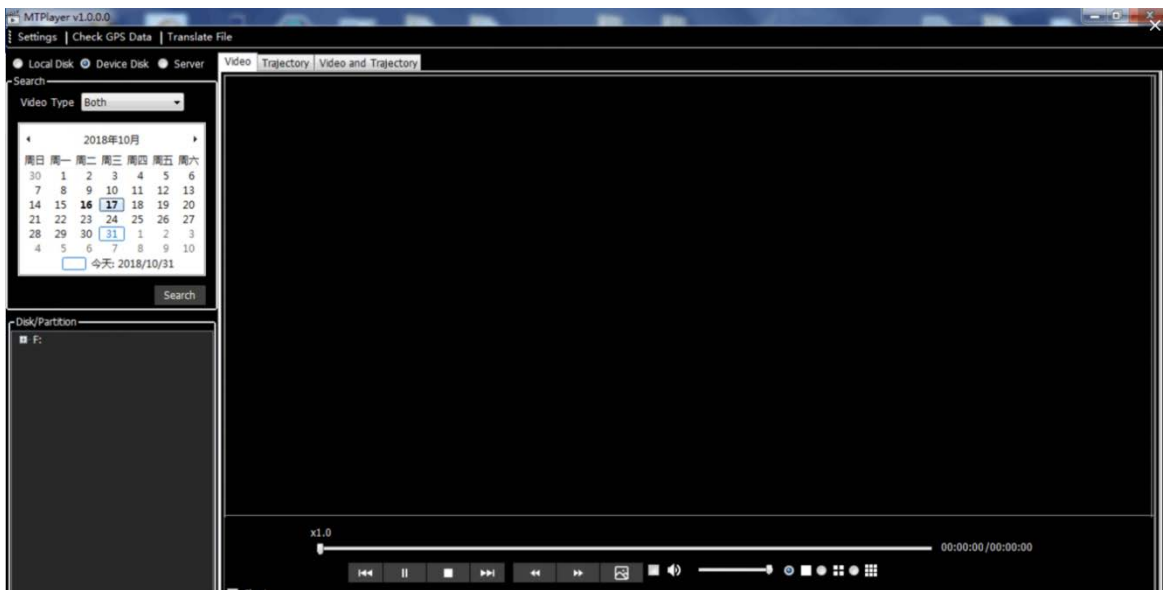

Double-click the name of a video file. Then the video will be played automatically.

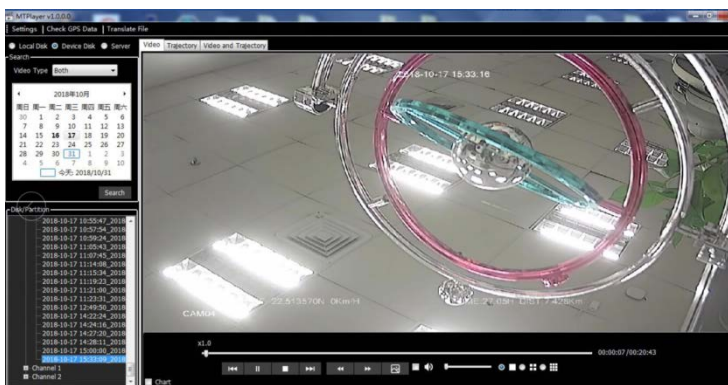

You can also download the video, and then play it.

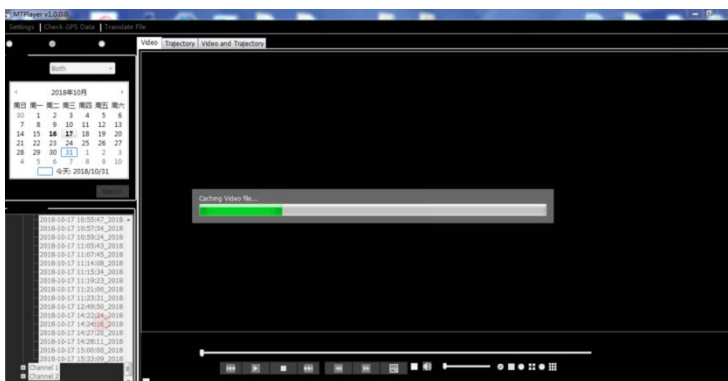

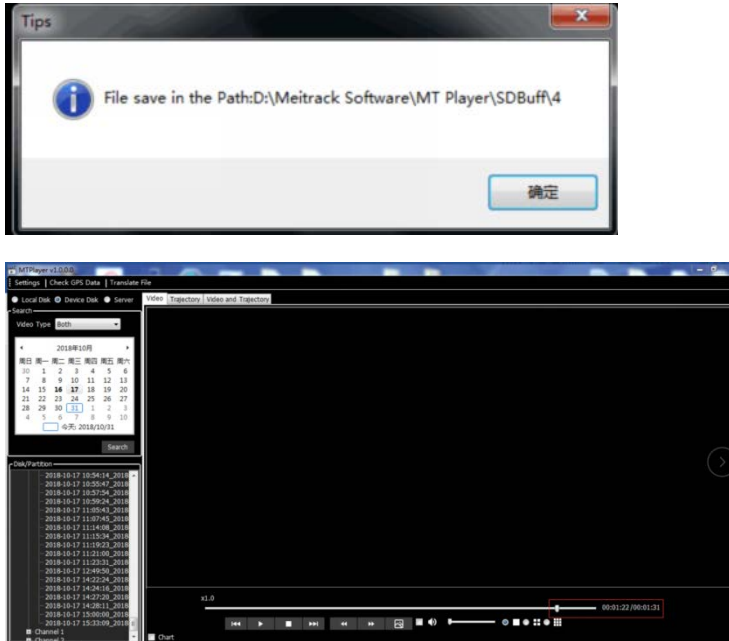

## 9 FAQs

### 9.1 MDVR Abnormal

- a) Q: Only SYS and GPS LED indicators are on, and the MDVR does not record videos. Why?  
A: Check whether the ACC cable is connected to the positive terminal of the external power supply (or the ACC is on), and whether the hard disk is locked by using the key.
- b) Q: The blinking of the LED indicator of the storage disk (SD card/hard disk) is abnormal, and the MDVR does not record videos. Why?  
A: Check whether there are video recordings at the specified time periods. If the problem still exists, please restart the MDVR.
- c) Q: Available WiFi networks cannot be searched, or searched WiFi signal values are low.  
A: Please install the WiFi antenna to improve WiFi signal strength.

### 9.2 Data Usage Consumption

Data usage depends on the size of data uploaded from the device. Uploaded data contains video data and positioning data.

Video data calculation formula:  $\text{Bitrate (Kbs)} / 8 \times \text{Number of channels} / 1024 = \text{Data usage consumption per second (MB)}$

**(Note: The formula is applicable to scenarios that the device is monitored continuously via the platform or uploads video files continuously. It will become unavailable when functions of monitoring and FTP uploading are enabled at the same time or operators have special data usage calculation methods.)**

Positioning data calculation formula:  $0.2\text{KB} \times 3600 / \text{GPRS interval} \times 24 / 1024 = \text{Data usage consumption per hour (MB)}$

**(Note: The formula is applicable to general use scenarios. It will become unavailable when commands are frequently sent to read and write, photos are frequently uploaded, or operators have special data usage calculation methods.)**

Under normal circumstances, data usage of the device is as follows:

<b>Good image quality: 1080p (1920 X 1080); Bitrate: 3,072 Kbs; Frame Rate: 25</b>						
	Data Usage Within 10 Minutes (GB)	Data Usage Within 1 Hour (GB)	Data Usage Within 1 Day (GB)	Data Usage Within 1 Week (GB)	Data Usage Within 1 Month (GB)	Data Usage Within 1 Year (GB)
1 channel	0.22	1.32	31.7	221.9	951	11570.5
2 channels	0.44	2.64	63.4	443.8	1902	23141
4 channels	0.88	5.28	126.7	886.9	3801	46245.5
8 channels	1.76	10.56	253.4	1773.8	7602	92491

<b>Average image quality: 720p (1280 X 720); Bitrate: 2,048 Kbs; Frame Rate: 25 FPS</b>						
	Data Usage Within 10 Minutes (GB)	Data Usage Within 1 Hour (GB)	Data Usage Within 1 Day (GB)	Data Usage Within 1 Week (GB)	Data Usage Within 1 Month (GB)	Data Usage Within 1 Year (GB)
1 channel	0.15	0.9	21.6	151.2	604.8	7257.6
2 channels	0.3	1.8	43.2	302.4	1209.6	14515.2
4 channels	0.6	3.6	86.4	604.8	2419.2	29030.4
8 channels	1.2	7.2	172.8	1209.6	4838.4	58060.8

<b>Bad image quality: DA (704 X 576); Bitrate: 512 Kbs; Frame Rate: 25 FPS</b>						
	Data Usage Within 10 Minutes (GB)	Data Usage Within 1 Hour (GB)	Data Usage Within 1 Day (GB)	Data Usage Within 1 Week (GB)	Data Usage Within 1 Month (GB)	Data Usage Within 1 Year (GB)
1 channel	0.0375	0.225	5.4	37.8	151.2	1814.4
2 channels	0.075	0.45	10.8	75.6	302.4	3628.8
4 channels	0.15	0.9	21.6	151.2	604.8	7257.6
8 channels	0.3	1.8	43.2	302.4	1209.6	14515.2

<b>Best image quality: 1080p (1920 X 1080); Bitrate: 8,192 Kbs; Frame Rate: 25</b>						
	Data Usage Within 10 Minutes (GB)	Data Usage Within 1 Hour (GB)	Data Usage Within 1 Day (GB)	Data Usage Within 1 Week (GB)	Data Usage Within 1 Month (GB)	Data Usage Within 1 Year (GB)
1 channel	0.59	3.54	84.96	594.72	2548.8	31010.4
2 channels	1.18	7.08	169.92	1189.44	5097.6	62020.8
4 channels	2.36	14.16	339.84	2378.88	10195.2	124041.6
8 channels	4.72	28.32	679.68	4757.76	20390.4	248083.2

- 1) Q: If the device is monitored occasionally via the platform and not all video files need to be uploaded, how much data usage will be consumed?  
A: The data usage depends on the number of alerts. Each alert video lasting one minute consumes about 180 MB. Under normal circumstances, if the monitoring frequency is not high (one hour per day; DA image quality) and the number of alerts is few (10 alerts per day), the data usage consumption per day is about 3.8 GB.
- 2) Q: What is the difference between the data usage generated during monitoring and the data usage generated by files uploaded to the FTP server?



A: The data usage generated during monitoring is calculated based on live stream, while the data usage generated by files uploaded to the FTP server is calculated based on storage stream.

### 9.3 Power Consumption

The device's power consumption varies depending on the following three conditions:

Sleep mode: 96 mA

Eight cameras and a display: 2–4 A

A single camera: 100–400 mA (The light in the daytime is strong, so the power consumption is low. The light in the night is weak, so the power consumption is high.)

1) Q: If the engine is not started, will the vehicle battery be quickly consumed by the device?

A: If the engine is not started, the recording function of the device is disabled. So the power consumption will be lower than 100 mA and excessive consumption of the vehicle battery will not happen.

2) Q: How to reduce the power consumption?

A: You can reduce the number of peripherals, alert event uploading times and camera channels.

### 9.4 Video Storage

The maximum storage capacity of the MDVR varies depending on the capacity of hard disks on the market. The MDVR supports a hard disk with a capacity of 256 GB, 512 GB, 1 TB, or 2 TB. So users can choose a proper hard disk as needed. For details about the storage time of the device with different capacity, see the following tables. As shown in the following tables, the storage time of the storage disk with the largest capacity ranges from three days to 320 days due to the image quality and the number of channels.

<b>Good image quality: 1080p (1920 X 1080); Bitrate: 3,072 Kbs; Frame Rate: 25</b>				
	1-channel camera	2-channel camera	4-channel camera	8-channel camera
Storage time of a 256 GB hard disk (hour)	160	80	39	20
Storage time of a 512 GB hard disk (hour)	320	160	78	40
Storage time of a 1 TB hard disk (day)	26	13	6.5	4
Storage time of a 2 TB hard disk (day)	52	26	13	7

<b>Average image quality: 720p (1280 X 720); Bitrate: 2,048 Kbs; Frame Rate: 25 FPS</b>				
	1-channel camera	2-channel camera	4-channel camera	8-channel camera
Storage time of a 256 GB hard disk (hour)	240	120	60	30
Storage time of a 512 GB hard disk (hour)	480	240	120	60
Storage time of a 1 TB hard disk (day)	40	20	10	5
Storage time of a 2 TB hard disk (day)	80	40	20	10

<b>Bad image quality: DA (704 X 576); Bitrate: 512 Kbs; Frame Rate: 25 FPS</b>				
	1-channel camera	2-channel camera	4-channel camera	8-channel camera
Storage time of a 256 GB hard disk (hour)	960	480	240	120
Storage time of a 512 GB hard disk (hour)	1920	960	480	240
Storage time of a 1 TB hard disk (day)	160	80	40	20
Storage time of a 2 TB hard disk (day)	320	160	80	40

<b>Best image quality: 1080p (1920 X 1080); Bitrate: 8,192 Kbs; Frame Rate: 25</b>				
	1-channel camera	2-channel camera	4-channel camera	8-channel camera
Storage time of a 256 GB hard disk (hour)	60	30	15	7.5
Storage time of a 512 GB hard disk (hour)	120	60	30	15
Storage time of a 1 TB hard disk (day)	10	5	2.5	1.2
Storage time of a 2 TB hard disk (day)	20	10	5	3

- 1) Q: What will happen if the hard disk and SD card are full?  
A: If the hard disk and SD card are full, original video recordings will be automatically replaced with new ones by default. So you need to upload or back up video files regularly. If you don't want data to be replaced, set the function of "stopping recording after the disk is full" by Meitrack Manager software.
- 2) Q: Can I extend the storage time of the hard disk by reducing the frame rate?  
A: Yes. The reduction of the frame rate will affect the smoothness of video images while extending the storage time by 10% to 50%. But it is recommended that the frame rate should be greater than 15 FPS. Otherwise, images will be discontinuous.

## 9.5 Camera Installation

Cameras are installed horizontally by default. If cameras need to be installed in an inverted position or on the side, perform the following steps:

- (1) Loosen the screws and remove the camera.



- (2) Confirm the installation location and nail holes.



- (3) Drill holes in nail holes by using provided nails, hammer the nails into the holes, and install the bottom part of the camera.



- (4) Rotate the camera to adjust its angle. To ensure images do not display upside down or are misplaced, check the camera angle by using the platform or display.



- (5) Twist the iron ring to fix the camera.



(6) If you do not want to fasten the camera by tightening the screws, use double-sided tape instead.



If you have any questions, do not hesitate to email us at [info@meitrack.com](mailto:info@meitrack.com).