

MEITRACK® P66 User Guide



Change History

File Name	MEITRACK P66 User Guide		
Project	P66	Creation Date	2015-04-17
		Update Date	2018-03-14
Subproject	User Guide	Total Pages	14
Version	V1.4	Confidential	External Documentation

Contents

1 Copyright and Disclaimer.....	- 4 -
2 Product Introduction	- 4 -
3 Product Functions and Specifications	- 4 -
3.1 Product Functions.....	- 4 -
3.2 Working Mode.....	- 4 -
3.3 Specifications.....	- 7 -
4 Device and Accessories.....	- 8 -
5 About the P66.....	- 8 -
5.1 Appearance.....	- 8 -
5.2 LED Indicator.....	- 9 -
6 First Use	- 10 -
7 Quick Operation Command	- 11 -
7.1 Tracking by Mobile Phone.....	- 11 -
7.2 Setting a Heartbeat Packet Reporting Interval – A11.....	- 12 -
7.3 Waking the Device Up by Vibration – A19	- 12 -
7.4 Setting the Man Down Alert – A29	- 12 -
7.5 Setting SOS Phone Numbers – A71.....	- 13 -
8 Logging In to MS03 Tracking System.....	- 13 -
9 Safety and Usage Instructions	- 13 -

1 Copyright and Disclaimer

Copyright © 2018 MEITRACK. All rights reserved.

 and  are trademarks that belong to Meitrack Group.

The user manual may be changed without notice.

Without prior written consent of Meitrack Group, this user manual, or any part thereof, may not be reproduced for any purpose whatsoever, or transmitted in any form, either electronically or mechanically, including photocopying and recording.

Meitrack Group shall not be liable for direct, indirect, special, incidental, or consequential damages (including but not limited to economic losses, personal injuries, and loss of assets and property) caused by the use, inability, or illegality to use the product or documentation.

2 Product Introduction

The P66 is a personal tracking unit featuring IP66 water resistance rating and ultra-low power consumption. It is specially designed for elderly falling detection, children positioning and tracking, asset tracking and fixed asset anti-theft, and supports real-time location positioning and tracking, SOS alert, two-way calling and listen-in. In addition, it supports 3 working modes and has a maximum of 10 days of standby time.

3 Product Functions and Specifications

3.1 Product Functions

- GPS + LBS positioning
- Real-time location query/Track by time interval/Track by distance
- Real-time monitoring by app
- SOS alert
- Listen-in and two-way calling
- Cornering report
- Speeding alert
- GPS blind spot alert
- Low power alert for internal battery
- Enter/Exit geo-fence alert
- GPRS blind spot resend
- IP66 water resistance rating
- Smart vibration wakeup function
- Man down alert

3.2 Working Mode

The device supports 3 working modes to reduce power consumption and extend battery life.

- 1) Long Standby Mode (default): In this mode, you can set at most 24 time points for the device, such as 06:00, 07:15 or 08:50. At the preset time point, the device will automatically send a piece of positioning data to the tracking platform, and then it will automatically enter the sleep mode. At other time points, the device will not

send data. The standby time varies depending on network conditions. The longest standby time is 260 hours.

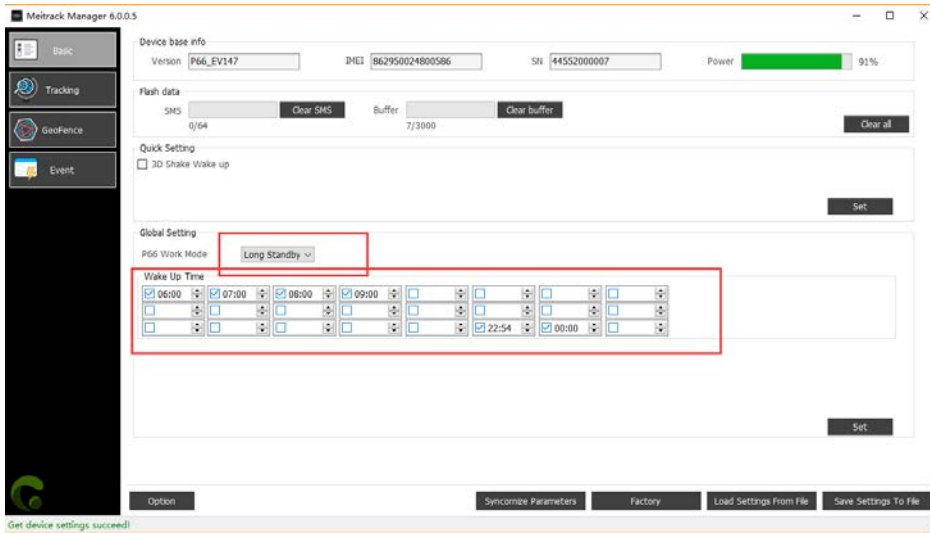

- 2) SOS Mode: In this mode, the device will send alerts and location information only when the SOS button is pressed. Then it will automatically enter the sleep mode and will not send data.

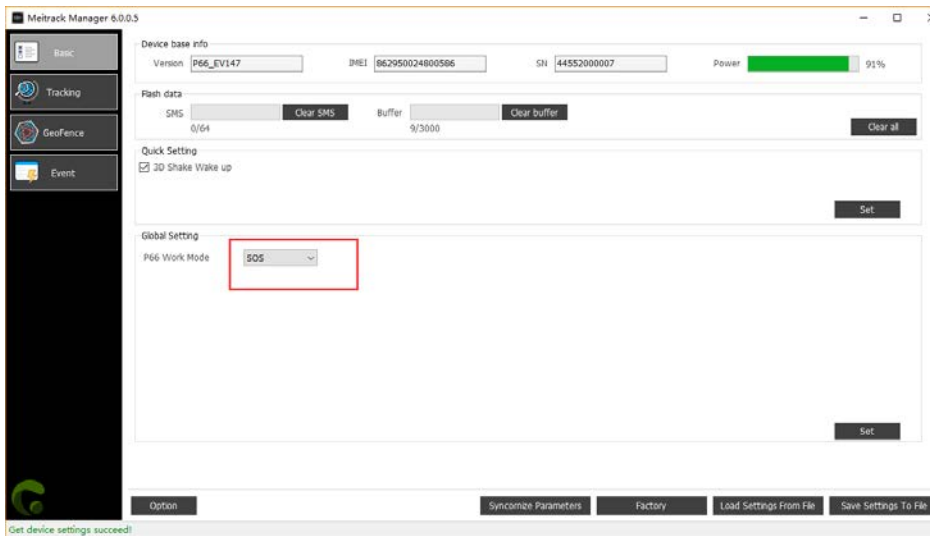

In this mode, you can enable the man down alert. The man down alert is valid only in this mode. After the alert is enabled and a man down alert is triggered, the device will be woken up automatically and will send a piece of positioning data to the tracking platform. Then it will enter the sleep mode. The standby time varies depending on the alert and network conditions. The longest standby time is 260 hours.

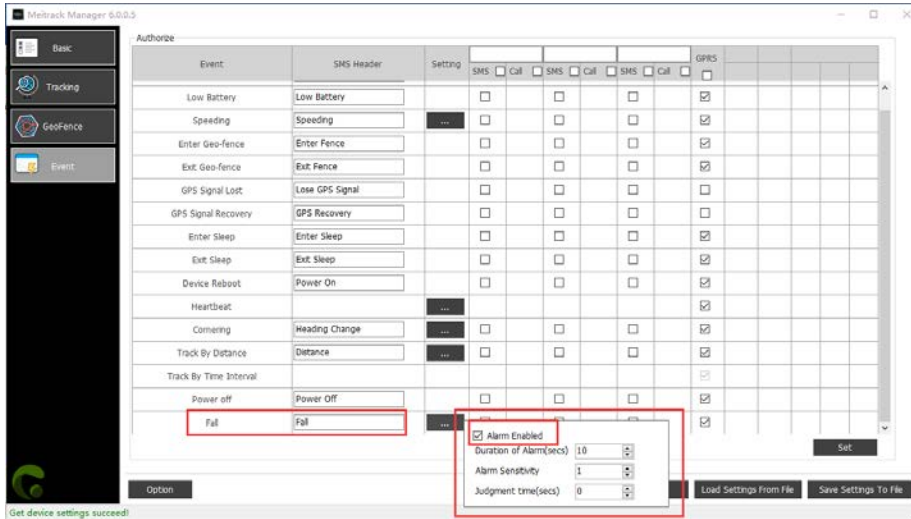

- 3) Normal Mode: In this mode, the device will send a piece of data at a specific time interval (60 seconds by default) to the tracking platform. Five minutes after the device stops moving (no vibration detected), it will automatically enter the sleep mode. In the sleep mode, the device will send a heartbeat packet at a specific time interval (60 minutes by default). The standby time varies depending on network conditions. The longest standby time is 150 hours.

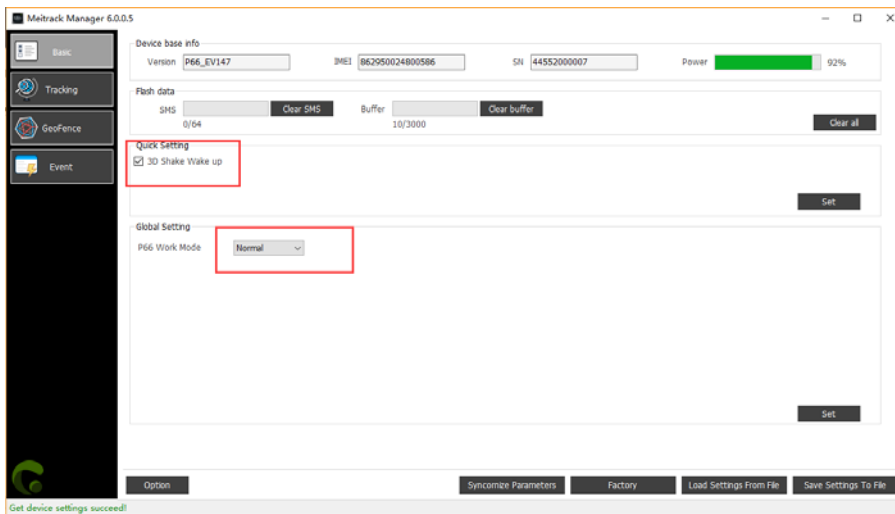

Note:

- a) In the previous 3 working modes, you can select **3D Shake Wake Up** on Meitrack Manager software. When the device enters the sleep mode, it will be woken up automatically once it detects vibration. Meanwhile, it will send a piece of positioning data to the tracking platform.

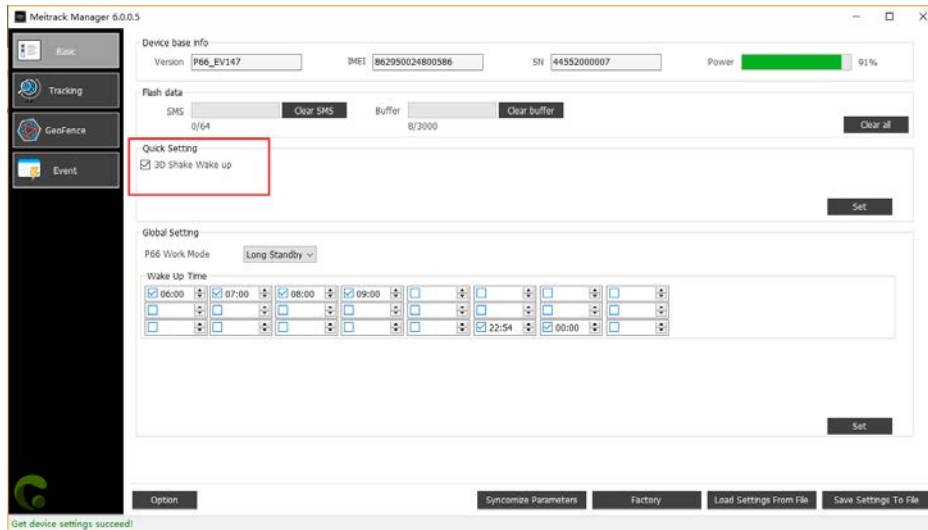

- b) The working mode can be set by Meitrack Manager only, while the wakeup by vibration, man down alert (only valid in SOS mode) and heartbeat packet time interval can be set by Meitrack Manager or SMS command.
 Note: No USB cable included in the standard package. Please use a standard USB cable for Android devices.

3.3 Specifications

Item	Specifications	Remarks
Dimension	61 mm x 41 mm x 16 mm	
Weight	43g	
Charging voltage	DC charging port, DC 4.5–5.5 V/500 mA	
Backup battery	600 mAh/3.7 V, Li-polymer battery	
Power consumption	Current in standby mode: 56 mA Current in deep sleep mode: 4.3 mA	For details, see section 3.2 "Working Mode."
Operating temperature	-20°C to 55°C	Ensure that the device can work properly in this environment.
Operating humidity	5%–95%	Ensure that the device can work properly in this environment.
Working hour	Continuous 12 hours	For details, see section 3.2 "Working Mode."
LED indicator	3 indicators showing power, GSM, and GPS status	For details, see section 0 "LED Indicator."
Button/Switch	2 buttons/switches	For details, see section 5.1 "Appearance."
Microphone/Speaker	Internal microphone and speaker	Used for auto answer and two-way calling.
Memory	250 KB buffer (Store 3,000 GPRS cache records and 64 SMS cache records)	GPRS and SMS: Data will be uploaded automatically after the signal recovers.
Sensor	3-axis accelerometer	Determine movement, stillness, and vibration.
Frequency band	GSM 850/900/1800/1900 MHz	
GPS sensitivity	-161 dB	
Positioning accuracy	2.5m	

4 Device and Accessories

- P66 tracker
- P66 Quick Start Guide
- Charger
- Charging cable (circular connector)
- CD download card
- USB cable (optional)

5 About the P66

5.1 Appearance

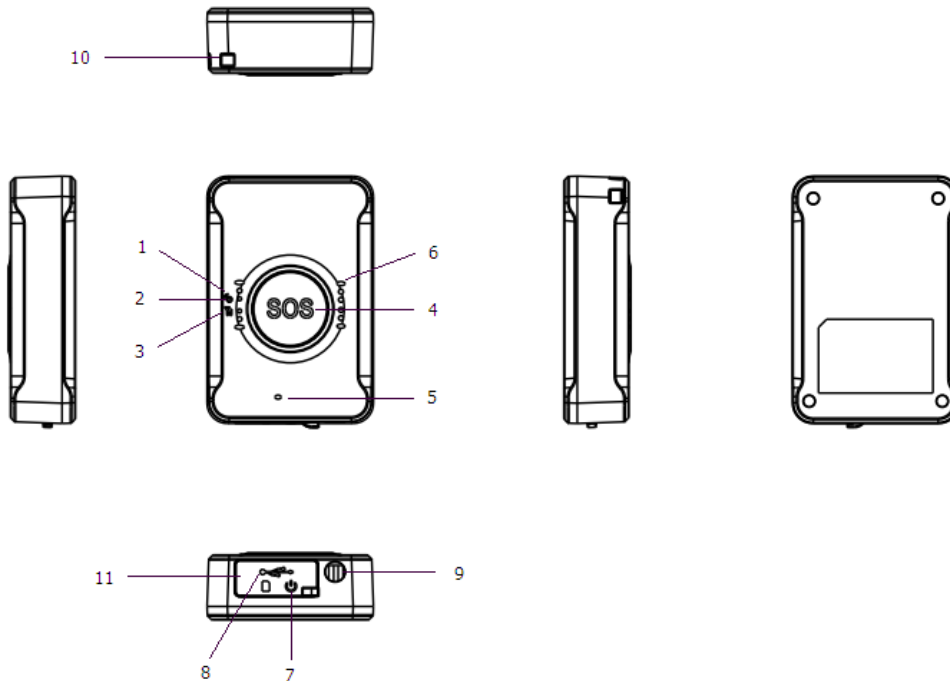

No.	Item	Description
1	Power indicator (red)	Indicates the charging or low power state. For details, see section 0 "LED Indicator."
2	GPS indicator (blue)	Indicates GPS status. For details, see section 0 "LED Indicator."
3	GSM indicator (green)	Indicates GSM status. For details, see section 0 "LED Indicator."
4	SOS button	Press and hold down the button for 2 seconds in the case of emergency. The device will beep once. The device will also dial three authorized phone numbers in sequence. It will stop dialing when one phone number answers. Meanwhile, the device will send an SMS with positioning information to authorized phone numbers. If the GPRS function is enabled, the device will send a GPRS message

		to the server.
5	Microphone	It will operate automatically when the call function is used.
6	Speaker	It will operate automatically when the call function is used.
7	Power button	<ul style="list-style-type: none"> ● When the device is turned off, press and hold down the button for 2 seconds. The device will beep twice, indicating that it will be turned on. ● When the device is turned on, press and hold down the button for 2 seconds. The device will beep once, indicating that it will be turned off.
8	Micro USB port	Used for charging the device, configuring parameters, and upgrading software.
9	Charging port	Used for charging the device.
10	Lanyard hole	Place the lanyard through the hole.
11	Elastic rubber cover	After you open the elastic rubber cover, install the SIM card and plug the USB cable into the USB port for charging or parameter configuration.

5.2 LED Indicator

To start the device, press and hold down the power button for 2–3 seconds. Then the blue and green indicators will blink on for 1 second and blink off for 1 second simultaneously.

GPS Indicator (Blue)	
Steady off	The device is powered off or in sleep mode.
Blink (1 second on and 1 second off)	The GPS is invalid or the device is initializing.
Blink (0.1 seconds on and 5 seconds off)	The GPS is valid.
GSM Indicator (Green)	
Steady on	A call is coming in, or the SOS button is pressed.
Steady off	The device is powered off or in sleep mode.
Blink (1 second on and 1 second off)	No signal is received, or the device is initializing.
Blink (0.1 seconds on and 5 seconds off)	The device is connected to the GSM network.
Power Indicator (Red)	
Steady on	The device is charging.
Steady off	The device is powered off or in sleep mode.
Blink 5 times (0.2 seconds on and 0.2 seconds off for 5 consecutive times), and then 5 seconds off	The device has low power.

Note: While using, all indicators of the device will be steady off automatically after it is powered on for about three minutes, and thus to save power. If you want to know about indicator status, press the SOS button. Then indicators will blink.

6 First Use

	<p>1. Open the elastic rubber cover.</p>
	<p>2. Insert the SIM card. Gently push the SIM card into the slot until you hear a click with the gold-colored side facing up. Note: Ensure that the SIM PIN lock is closed, and the SIM card has sufficient balance and has subscribed the call ID service. If you want to use the GPRS function, learn about the SIM card GPRS charging first.</p>
	<p>3. Close the elastic rubber cover. Press the cover firmly.</p>
	<p>4. Charge the battery. Before using the device for the first time, you are advised to charge the battery for 8 hours. To charge the battery, you can connect the device to the charger or a computer through the USB cable. Note: While charging, the device may heat up. This is normal and does not affect your device's lifespan or performance. If the battery is low, it may affect positioning and data transmission. In this way, charge the battery before using.</p>
	<p>Charge with the charger: Connect the USB cable, and plug the charger into the power socket.</p>
	<p>(Optional) Attach a lanyard: Attach a lanyard as required.</p>

Note: After you install the SIM card and charge the battery, the device automatically starts, and you can use your device normally.

7 Quick Operation Command

Before use, you need to set common parameters by SMS command or Meitrack Manager to connect the network and send data to the tracking platform.

For details about how to set parameters, please see the *Meitrack Manager User Guide*.

For details about SMS commands, please see the *Meitrack SMS Protocol*.

7.1 Tracking by Mobile Phone

This section describes how to query device's current location.

Call the device's SIM card number, and hang up after the dial tone rings 2–3 times. The device will reply to an SMS with a map link.

Click the SMS link. The device's location will be displayed on Google Maps on your mobile phone.

Note: If an authorized phone number was set by SMS command A71, only this phone number can receive SMS reports.

SMS example:

Now,110727 02:48,V,16,23Km/h,61%,<http://maps.google.com/maps?f=q&hl=en&q=22.540103,114.082329>

The following table describes the SMS format:

Parameter	Description	Remarks
Now	Indicates the current location.	SMS header: indicates the current location or the alert type. For details about the SMS header, see the <i>MEITRACK SMS Protocol</i> and <i>MEITRACK GPRS Protocol</i> .
110727 02:48	Indicates the date and time in YYMMDD hh:mm format.	None
V	The GPS is invalid.	A = Valid V = Invalid
16	Indicates the GSM signal strength.	Value: 1–32 The larger the value is, the stronger the signal is. If the value is greater than 12, GPRS reaches the normal level.
23Km/h	Indicates the speed.	Unit: km/h
61%	Indicates the remaining battery power.	None
http://maps.google.com/maps?f=q&hl=en&q=22.540103,114.082329	Indicates the map link. Latitude: 22.540103 Longitude: 114.082329	None

If your mobile phone does not support HTTP, enter the latitude and longitude on Google Maps to query a location.

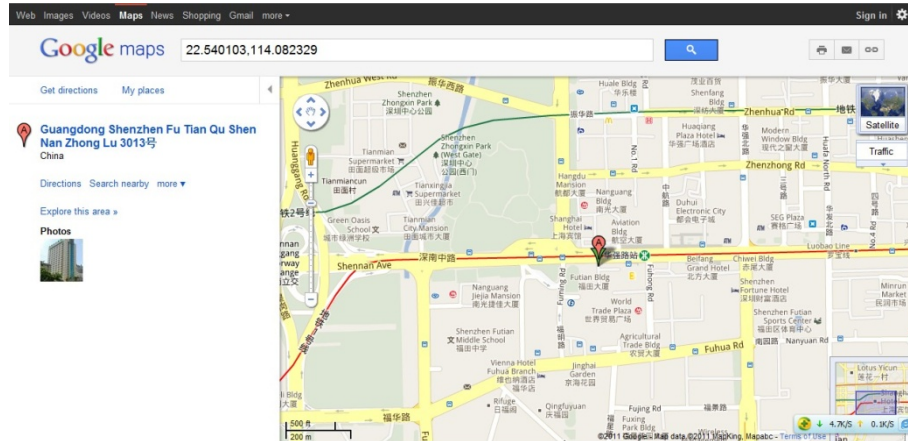

Note: The default tracker password is **0000**, which can be changed by using Meitrack Manager or SMS command. After the password is changed successfully by using an SMS command, only the authorized phone number can receive SMS reports. The common format of an SMS command is: *Password,Command,Parameter*.

7.2 Setting a Heartbeat Packet Reporting Interval – A11

The heartbeat function is available only in conjunction with deep sleep mode. When the device enters deep sleep mode, a heartbeat packet will be sent at the specified interval. A heartbeat packet is to confirm the device is online, and positioning data is invalid.

SMS sending: 0000,A11,*Interval*

Example: 0000,A11,30

7.3 Waking the Device Up by Vibration – A19

When the device detects vibration, it will be woken up automatically and send positioning data.

SMS sending: 0000,A19,*X*

X = 0: The device will not be woken up by vibration.

X = 1: The device will be woken up by vibration (default).

Example: 0000,A19,1

7.4 Setting the Man Down Alert – A29

When the device detects a valid man down alert, it will be woken up automatically and send positioning data.

SMS sending: 0000,A29,*Switch,Time,Grade*

1. Switch: Whether to enable the man down alert detection function. The value is **0** or **1**. When the parameter value is **1**, the man down alert function is enabled. When the parameter value is **0**, the man down alert function is disabled.
2. Time: indicates the buzzing and vibration time after the device falls to the ground. During this period, you can press any button of the device to clear the alert, so as to avoid misinformation. If no button is pressed during this period, a man down alert will be generated or the tracker will call the designated contact. Unit: second; value range: 0–255; default value: 10.
3. Grade: indicates the man down alert level. Its value ranges from 0 to 3 and it is in decimal format. The default value is **1**. The smaller the value is, the higher the alert probability is.

Example: 0000,A29,1,10,1,0

7.5 Setting SOS Phone Numbers – A71

This command is used to set SOS phone numbers. When you dial a phone number, an SMS report about the location and other functions will be received.

- SMS text:

`0000,A71,Phone number 1,Phone number 2,Phone number 3`

Send the text to the embedded SIM card phone number.

Tip: “,” should be an English comma and no space exists before and after the comma.

- The device will automatically reply to the SMS: `IMEI,A71,OK`. It indicates that the SOS phone number is set successfully.

Note:

Phone number: Contains a maximum of 16 bytes. If no phone numbers are set, leave them blank. Phone numbers are empty by default.

Phone number 1: Set the phone number to the SOS phone number. When you call the tracker by using the phone number, you will receive SMS notification about the location, geo-fence alert and low power alert.

Phone number 2/3: When you call the tracker, the tracker replies to an SMS with location information.

- When you press the SOS button, the device will dial three authorized phone numbers in sequence. It will stop dialing when one phone number answers. Then the two-way calling is implemented. After hanging up, the tracker will send alert information to phone numbers.
- When you call the device by using a preset phone number, the device will automatically answer by default and implement two-way calling.

Note: The phone numbers are blank by default. The phone numbers that are set must be separated by comma (“,”) to avoid setting failures. No comma is required next to the last phone number. For example:

`0000,A71,13500000000,,`

`0000,A71,13500000000,13600000000,`

`0000,A71,13500000000,13600000000,13700000000`

Reply: `353358017784062,A71,OK`

To clear all phone numbers, send `0000,A71,,`.

8 Logging In to the free MS03 Tracking System

Please visit <http://ms03.trackingmate.com/reg.aspx>, and apply for a login account. The account is free for 2 years only.

The MS03 supports the following functions:

- Track by time interval or distance.
- Query historical trips.
- View various reports.

For details, see the *MEITRACK GPS Tracking System MS03 User Guide*.

Note: On the free MS03 platform, only the location query function can be used.

9 Safety and Usage Instructions

Use only Meitrack-approved accessories.

Incompatible accessories may cause serious injuries or damages to your device.

Handle the battery and charger carefully.

- Use batteries specified by Meitrack and chargers exclusively designed for your device. Incompatible batteries and chargers may cause serious injuries or damages to your device.
- Do NOT place batteries or devices on fire or in heating devices, such as microwave ovens, ovens, or radiators. Batteries may explode when overheated.

If you have any questions, do not hesitate to email us at info@meitrack.com.