

MEITRACK T322X User Guide



Change History

File Name	MEITRACK T322X User Guide	Created By	Kyle Lv
Product	T322X	Creation Date	2014-06-04
		Update Date	2016-12-12
Subproject	User Guide	Total Pages	16
Version	V1.3	Confidential	External Documentation

Contents

1 Copyright and Disclaimer	- 4 -
2 Product Overview	- 4 -
3 Product Functions and Specifications	- 4 -
3.1 Product Functions	- 4 -
3.1.1 Position Tracking	- 4 -
3.1.2 Anti-Theft	- 4 -
3.1.3 Other Functions	- 5 -
3.1.4 Functions of Optional Accessories	- 5 -
3.2 Smart Voice	- 5 -
3.3 Smart Sleep Mode	- 5 -
3.4 Data Compression Mode – CCC	- 6 -
3.5 Specifications	- 6 -
4 T322X and Accessories	- 7 -
5 Product View	- 7 -
6 First Use	- 8 -
6.1 Installing the SIM Card	- 8 -
6.2 LED Indicator	- 9 -
6.3 Configuring Device Parameters by Meitrack Manager	- 9 -
6.4 Tracking by Mobile Phone	- 10 -
6.5 Common SMS Commands	- 11 -
6.5.1 Setting Authorized Phone Numbers	- 11 -
6.5.2 Setting Anti-Theft (Arming/Disarming)	- 12 -
7 Logging In to MS03 Tracking System	- 13 -
8 Installing the T322X	- 13 -
8.1 (Optional) Installing the GPS Antenna	- 13 -
8.2 Installing an I/O Cable	- 13 -
8.2.1 Port Definition	- 13 -
8.2.2 Port View	- 14 -
8.2.3 Power Cable/Ground Wire	- 15 -
8.2.4 ACC and Door Detection	- 15 -
8.2.5 Remote Power Cut-off	- 16 -
8.2.6 (Optional) Buzzer Alarm	- 16 -
8.3 Mounting the T322X	- 16 -

1 Copyright and Disclaimer

Copyright © 2016 MEITRACK. All rights reserved.

 and  are trademarks that belong to Meitrack Group.

The user manual may be changed without notice.

Without prior written consent of Meitrack Group, this user manual, or any part thereof, may not be reproduced for any purpose whatsoever, or transmitted in any form, either electronically or mechanically, including photocopying and recording.

Meitrack Group shall not be liable for direct, indirect, special, incidental, or consequential damages (including but not limited to economic losses, personal injuries, and loss of assets and property) caused by the use, inability, or illegality to use the product or documentation.

2 Product Overview

The T322X, a GPS vehicle tracker, is used for private vehicle anti-theft, official vehicle anti-theft, and personal tracking management. The tracker supports smart-voice commands for arming/disarming settings, device status query, and location query for a long time.

3 Product Functions and Specifications

3.1 Product Functions

3.1.1 Position Tracking

- GPS + GSM positioning
- Real-time location query
- Track by time interval
- Track by distance
- Track by mobile phone
- Speeding alarm
- Cornering report
- Geo-fence

3.1.2 Anti-Theft

- SOS alarm
- GPS antenna cut-off alarm
- External power cut-off alarm
- GPS blind spot alarm
- Remote engine cut-off alarm
- Engine or vehicle door status alarm
- Towing alarm
- Arming or disarming

3.1.3 Other Functions

- SMS/GPRS (TCP/UDP) communication (Meitrack protocol)
- Built-in 1 MB buffer for storing 5,000 GPRS cache records and 128 SMS cache records
- Mileage report
- Low power alarm for internal battery
- Smart sleep mode
- Smart voice setting

3.1.4 Functions of Optional Accessories

Accessory	Function
Buzzer	Anti-theft
Microphone	Listen-in
GPS antenna	Improve GPS reception.

3.2 Smart Voice

Dial the device's SIM card number by using an authorized mobile phone number to set the smart voice function. After dialing, the following voice prompt is played: "Hello. Arming, press 1; disarming, press 2; query arming status, press 3; query a location, press 4; listen-in, press 5. Thank you." Then, press the desired number on the phone to enable a function.

For details about the arming and disarming functions, see section 6.5.2 "Setting Anti-Theft (Arming/Disarming)".

Note: Before using the smart voice function, ensure that:

- Your phone number has been authorized.
- The SIM card used in the device has subscribed the caller ID service. Otherwise, you cannot use the smart voice function.

3.3 Smart Sleep Mode

The smart sleep function works in conjunction with the following.

Scenario 1: When the ACC detection line has not been used.

With no interruption for consecutive 15 minutes, the device enters smart sleep mode. In this way, the GPS module stops work, and the device stops uploading data. Heartbeat reports about GPS invalid will be sent to the platform every 60 minutes (the default interval can be changed). If vibration occurs, the device will awake and continue to operate and report data at the specific interval. Heartbeat reports will be also resumed.

Scenario 2: When the ACC detection line has been connected.

If the ACC is on, the device will operate normally and report data at the specific interval.

If ACC is off, without any vibration, the device immediately enters smart sleep mode (as same as Scenario 1); Heartbeat reports about GPS invalid will be sent to the platform every 60 minutes (the default interval can be changed). If vibration occurs or the engine starts, the device will awake and continue to operate and report data at the specific interval.

Note:

- When the device is being charged with a USB cable, it will operate normally, but will not enter smart sleep mode.
- Under smart sleep, the device has low power consumption. The device with built-in battery can sustain up to about 50 hours.

3.4 Data Compression Mode – CCC

Device communicates through Meitrack protocol. The header and tail of a data packet stay unchanged, but the middle part of the data packet has been uploaded with CCC data compressed format.

Note: Only proactively-uploaded data (such as timing, heartbeat, or alarm events) is uploaded in CCC data format. Commands sent by the platform and replied by the device have the same format as the commands in Meitrack GPRS Protocol.

3.5 Specifications

Item	Specifications
Dimension	70.5 mm x 54 mm x 19.5 mm
Weight	65g
Power supply	DC 11–36 V/1.5 A
Backup battery	350 mAh/3.7 V
Normal power consumption	Current in normal working mode: 45 mA (12 V; ACC ON; upload data every 10 seconds; average current)
Standby power consumption	6.5 mA (12 V; ACC OFF; no data uploading; average current)
Power consumption of the internal battery	90 mA (3.8 V; GPS ON; upload data every 10 seconds; average current)
Battery standby power consumption	7 mA (3.8 V; GPS OFF; no data uploading while GSM standby; average current)
Operating temperature	-20°C to 55°C
Operating humidity	5% to 95%
Working hour	50 hours in power-saving mode 3.5 hours in normal working mode
LED indicator	3 indicators, showing GSM, GPS, and power status
Button/Switch	1 SOS button (for sending SMSs or dialing) 1 power button 1 positive or negative door trigger switch (in the position where you insert a SIM card)
Memory	1 MB buffer (Store 5,000 GPRS cache records and 512 SMS cache records)
Sensor	Vibration sensor
Frequency band	GSM 850/900/1800/1900 MHz
GPS sensitivity	-161 dB
Positioning accuracy	10m
GSM antenna	Internal antenna
GPS antenna	(Optional) Internal/external MMCX antenna
I/O port	3 inputs, including 1 SOS, 1 door trigger (positive or negative), and 1 ACC detection 2 outputs, including 1 buzzer and 1 remote fuel cut-off circuit 1 analog detection input 1 USB port (used for charging the device, configuring parameters)

4 T322X and Accessories

Standard accessories:



T322X with a built-in battery



I/O cable



SOS button



USB cable



CD

Optional accessories:



Buzzer



GPS antenna



Microphone



Audio cable

5 Product View

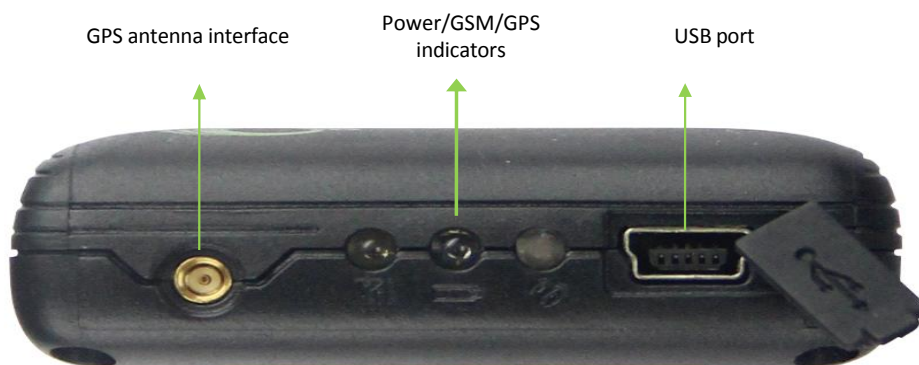
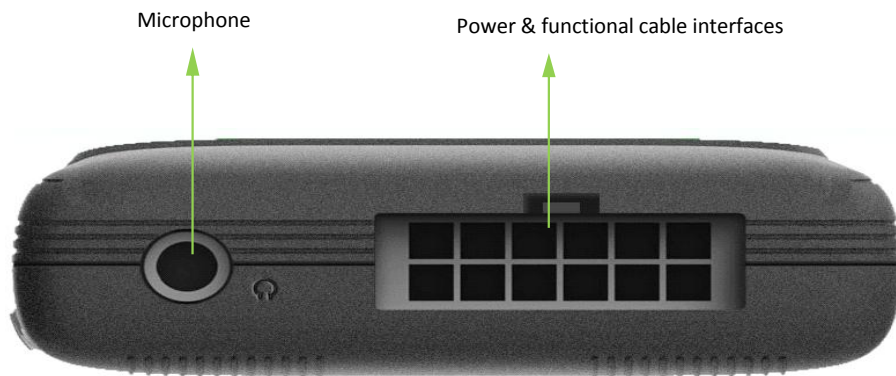



6 First Use

6.1 Installing the SIM Card



SIM card

To install the SIM card, open the SIM card cover, insert the card (card chip facing down), and close the card cover.

Note:

- Power off the device before installing the SIM card.
- Ensure that the SIM card has sufficient balance.
- Ensure that the phone card PIN lock has been closed properly.
- Ensure that the SIM card in the device has subscribed the caller ID service if you want to use your authorized phone number to call the device.

6.2 LED Indicator

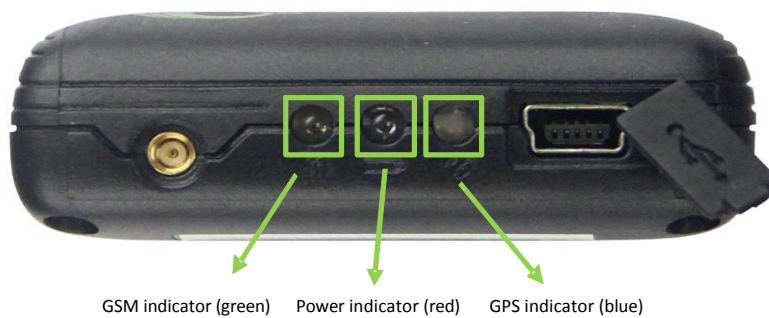

Use any of the following ways to start the device:

- Press and hold down the power button for 3–5 seconds.
- Connect the device to a computer by using a USB cable.
- Connect the device to an external power supply.

Note: When the device is being charged with a USB cable or by external power supply, it will operate normally. To restart the device, just press and hold down the power button.

GPS Indicator (Blue)	
Steady on	The GPS antenna is faulty.
Steady off	The GPS stops.
Blink (0.5 seconds on and 2.5 seconds off)	The GPS is valid.
Blink (1 second on and 2 seconds off)	The GPS is invalid.
GSM Indicator (Green)	
Steady on	A call is coming in or a call is being made.
Steady off	The SIM card is not inserted or is faulty.
Blink (0.5 seconds on and 2.5 seconds off)	The GSM signal is received.
Blink (1 second on and 2 seconds off)	The GSM signal is not received.
Power Indicator (Red)	
Steady on	The device is charging.
Blink (0.5 seconds on and 2.5 seconds off)	The device works normally.
Blink (1 second on and 2 seconds off)	The device power is low.

6.3 Configuring Device Parameters by Meitrack Manager

This section describes how to use Meitrack Manager to configure the device on a computer.

Procedure:

1. Install the USB-to-serial cable driver and Meitrack Manager.
2. Connect the device to a computer with the USB-to-serial cable.



3. Run Meitrack Manager, then the following dialog box will appear:



Turn on the device, then Meitrack Manager will detect the device model automatically and the parameter page will appear accordingly.

For details about Meitrack Manager, see the *MEITRACK Manager User Guide*.

6.4 Tracking by Mobile Phone

1. Use a mobile phone with an authorized phone number to call the device. It will enter the smart voice mode automatically.
2. Press 4 on the mobile phone according to the voice prompt. The device will reply to an SMS with a map link.
3. Click the SMS link. The device's location will be displayed on Google Maps on your mobile phone.

Note: Ensure that the device's SIM card number has subscribed the caller ID service. Otherwise, the tracking function by mobile phone will be unavailable.



SMS example:

Now,110721 16:40,V,10,0Km/h,97%,http://maps.meigps.com/?lat=22.513015&lng=114.057235

The following table describes the SMS format:

Parameter	Description	Remarks
Now	Indicates the current location.	SMS header: indicates the current location or the alarm type.
110721 16:40	Indicates the data and time in YYMMDD hh:mm format.	None
V	The GPS is invalid.	A = Valid V = Invalid
10	Indicates the GSM signal strength.	Value: 1–32 The larger the value is, the stronger the signal is. If the value is greater than 12, GPRS reaches the normal level.
OKm/h	Indicates the speed.	Unit: km/h
97%	Indicates the remaining battery power.	None
http://maps.meigps.com/?lat=22.513015&lng=114.057235	Indicates the map link. Latitude : 22.513015 Longitude : 114.057235	None

If your mobile phone does not support HTTP, enter the latitude and longitude on Google Maps to query a location.



6.5 Common SMS Commands

6.5.1 Setting Authorized Phone Numbers

SMS sending: 0000,A71,Phone number 1,Phone number 2,Phone number 3

SMS reply: IMEI,A71,OK

Description:

Phone number: a maximum of 16 bytes. If no phone numbers are set, leave them blank. Phone numbers are empty by default.
Phone number 1/2/3: SOS phone numbers. When you call the device by using these phone numbers, you will receive SMS notification about the location, geo-fence alarm and low power alarm and SMS notification or a call about the unauthorized door open and unauthorized ignition.

If you need to delete all authorized phone numbers, send **0000,A71**.

When the SOS button is pressed, the device dials phone numbers 1, 2, and 3 in sequence. The device stops dialing when a phone number responds. If the call is not answered after phone number 3 is dialed, the dialing ends.

Example:

Sending: 0000,A71,13811111111,13822222222,13833333333

Reply: 353358017784062,A71,OK

6.5.2 Setting Anti-Theft (Arming/Disarming)

You can set anti-theft by SMS command, call, or platform command.

Note: You can use a buzzer (optional accessory) to enhance the anti-theft protection. Set an authorized phone number to ensure that SMSs and calls can be received when a vehicle is stolen.

- Set by smart voice: Dial the device's SIM card number by using an authorized mobile phone number to set the smart voice function. After dialing, the following voice prompt is played: "Hello. Arming, press 1; disarming, press 2; query arming status, press 3; query a location, press 4; listen-in, press 5. Thank you." Then you press 1 to set arming.
- Set by SMS command: Set arming or disarming by SMS command.

SMS sending: 0000,B21,Status

SMS reply: IMEI,B21,OK

Note:

- When **Status** is **1**, enable the anti-theft function. While arming, opening the vehicle door and starting the ACC are not allowed. Otherwise, the device will send an alarm SMS and make a call to the preset authorized phone number.
- When **Status** is **0**, disable the anti-theft function. While disarming, all anti-theft alarms will be cleared. The device is in disarming state by default.

Function	Call	SMS	Engine Cut	Buzzer	Remarks
Opening the vehicle door	√	√		√	When the vehicle door is opened without permission, the buzzer will sound continuously until the anti-theft state is cancelled. The device will dial the three authorized phone numbers in sequence and send SMSs.
Starting the engine	√	√	√	√	When the engine is started, the vehicle fuel will be cut off, and the buzzer will sound continuously until the anti-theft state is cancelled. The device will dial the three authorized phone numbers in sequence and send SMSs.
Setting arming while driving (Intercepting the moving vehicle)		√	√		After the vehicle is stolen, you can send a GPRS/SMS command to intercept the moving vehicle. When the vehicle speed is lower than 5 km/h, the engine will be cut off, and the device will send an alarm to authorized phone numbers.
Towing alarm	√	√		√	When the ACC is off and vibration occurs continuously, a towing alarm will be generated. The device will dial the three authorized phone numbers in sequence and send SMSs.

Engine cut: Output ports are activated, implementing the remote fuel/power cut-off function. For details, see section 8.2.5 "Remote Power Cut-off."

For details about SMS commands, see the *MEITRACK SMS Protocol*.

Note:

1. The default SMS command password is **0000**. You can change the password by using Meitrack Manager and SMS command.
2. The device can be configured by SMS commands with a correct password. After an authorized phone number is set, only the authorized phone number can receive the preset SMS event report.

7 Logging In to MS03 Tracking System

Visit <http://ms03.trackingmate.com>, enter the user name and password, and log in to the MS03. (Purchase the login account from your provider.)

For more information about how to add a tracker, see the *MEITRACK GPS Tracking System MS03 User Guide* (chapter 4 "Getting Started").

The MS03 supports the following functions:

- Track by time interval or distance.
- Query historical trips.
- Set polygon geo-fences.
- Bind driver and vehicle information.
- View various reports.
- Send commands in batches.
- Support OTA updates.

For details, see the *MEITRACK GPS Tracking System MS03 User Guide*.

8 Installing the T322X

8.1 (Optional) Installing the GPS Antenna



If the GPS antenna is installed in a vehicle and the signal is weak, install an external GPS antenna to improve signal reception. Connect the GPS antenna to the GPS port. The antenna had better face towards the sky. Fasten the antenna by using the glue.

Note: Do not install the GPS antenna at a metal covered place.

8.2 Installing an I/O Cable

8.2.1 Port Definition

The I/O cable is a 12-pin cable, including the power, analog input, positive input, negative input, and output interfaces.



1	3	5	7	9	11
SOS ground wire (Black)	SOS (White)	Output 1 (Yellow)	Output 2 (Orange)	Input 2 (Brown)	Input 3 (Grey)

2 Device input power (Red)	4 Device ground wire (Black)	6 Ground wire (Black)	8 - (Yellow)	10 - (Green)	12 Analog input (Blue)
----------------------------------	------------------------------------	-----------------------------	-----------------	-----------------	------------------------------

No.	Function	Description
1	SOS ground wire	Used for input 1 (SOS) triggering.
2	Device input power	DC 11–36 V Undervoltage and overvoltage protection
3	Input 1 (SOS)	Negative triggering When input 1 is activated or the SOS button is pressed, an alarm is generated.
4	Device ground wire	Connect to the negative electrode of the vehicle battery.
5	Output 1 (fuel cut-off circuit)	Power: 1 W; 0–100 V Connect to the relay for fuel/power cut-off
6	Ground wire	None
7	Output 2 (buzzer alarm)	Connect to the negative electrode of the buzzer alarm
8	-	None
9	Input 2 (ACC input)	Positive triggering High level input (3–60 V) Used for ACC detection by default
10	-	None
11	Input 3 (door triggering)	The high level or low level triggering can be set. The negative triggering is selected by default. It is controlled by a DIP switch (near the SIM card slot). Used for vehicle door detection.
12	Analog input	0–47 V AD detection Connect to sensors with various voltage output. Formulas for calculating AD analog: <ul style="list-style-type: none"> ● AD1/100 (External analog detection value) ● AD4/100 (AD4 is the built-in battery voltage by default.) ● AD5/100 (AD5 is the external power voltage by default.)

8.2.2 Port View



Digital input 1 (SOS)

8.2.3 Power Cable/Ground Wire

Connect the power cable (red) and ground wire (black) to the positive and negative electrodes of the vehicle battery respectively.

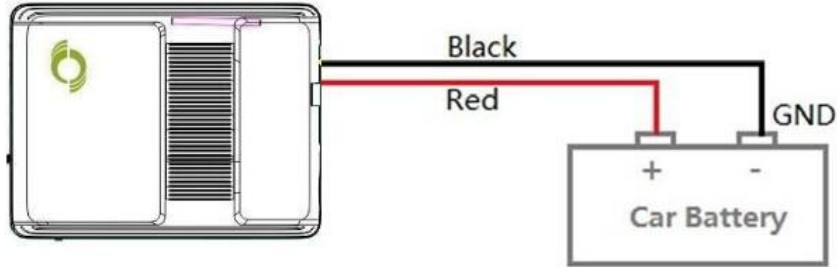

8.2.4 ACC and Door Detection

Connect the door detection after a correct trigger mode is set for the tracker.

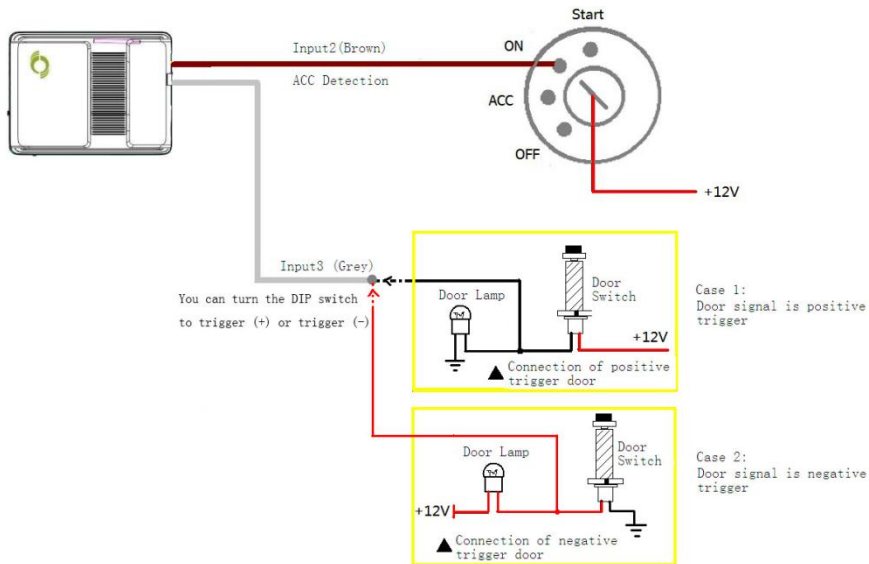

8.2.5 Remote Power Cut-off

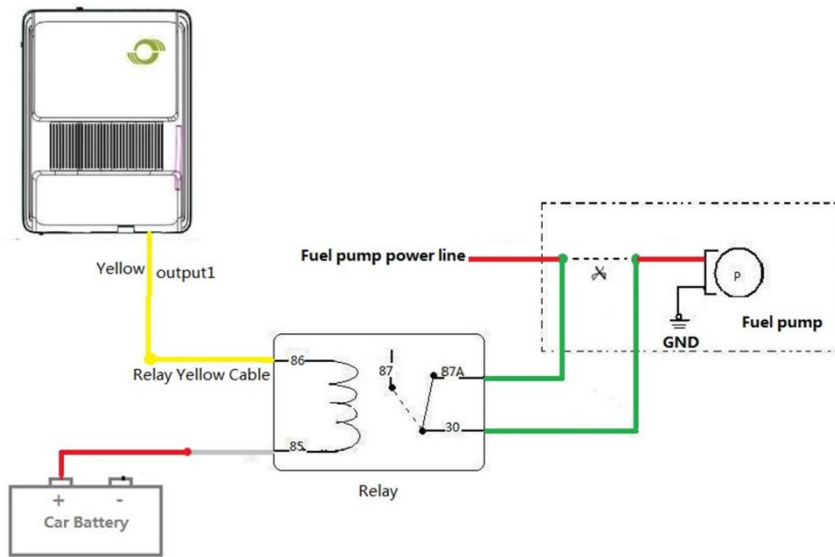

Note: To implement remote fuel/power cut-off, connect the relay to the fuel pump power cable or to the engine power cable in series.

8.2.6 (Optional) Buzzer Alarm

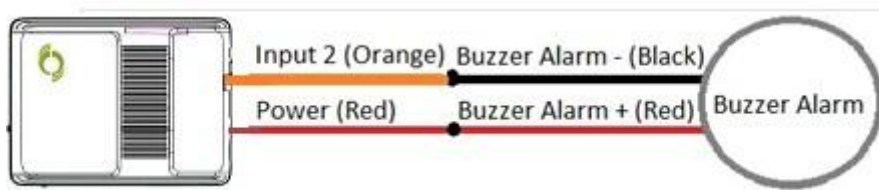

8.3 Mounting the T322X

Fasten the device in the vehicle by using cable ties.

The portable tracker can be connected to a cigarette lighter of the vehicle through an RS232 port by using a USB cable (5V input).

If you have any questions, do not hesitate to email us at info@meitrack.com.